

issue
13

1st March 2024
Price Guide

rhubarb
seating

we design for green, not for the bin



Seating made
Great in Britain

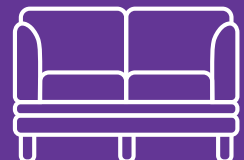

Welcome to Rhubarb Seating

Rhubarb designs and manufactures seating for every non-domestic environment. Our approach is founded on core principles which have the needs and interests of our customers at their heart.



Soft Seating



Multipurpose



Technical



Beam

Delivering what your project needs: we manufacture every product ourselves, NO element is sub-contracted, and all our soft seating is designed in-house. That means that if our standard products are not quite what is needed, we will create something from scratch or change the dimensions to fit.

Flexibility:

- Lead times – if you really need it in a hurry we can usually help
- Delivery schedules – we know projects do not always go to plan so we will be here to work with you to flex arrangements
- Support – whatever you need we will do our utmost to accommodate it, from product modification to warehousing for stock that can't be delivered to site
- Advice – on fabrics, foams, product construction to make sure you and your clients get the best solutions

Space planning: we are able to provide full space planning services where they will add value

Sustainability and social responsibility: we are proactively pursuing an agenda to net zero and regularly work with a social enterprise that provides employment and training for disadvantaged individuals and specialises in the manufacture of products using reclaimed timber.

We are confident the quality of our ranges will stand comparison with any other manufacturer and we pride ourselves on our personal approach to business and to the relationships that underpin it.



How to get the best from Rhubarb Seating

We hope this document will give you the information you need to select the right product for you or your customer's requirements; however, if you need any other information, or you can't find exactly what you are looking for, there may be other options.

Remember: as a manufacturer with our own in-house design team, we can produce bespoke solutions to fit specific needs or environments.

Price

The prices included here are our Recommended Retail Prices. We are all impacted by the continuing economic uncertainty and its effect on sterling but, as always, we have done our utmost to restrict price increases to a minimum by constantly driving efficiencies in our manufacturing processes.

What range?

On the following pages you will see we have made some suggestions as to what ranges suit certain environments and we have also listed our products by use.

What product?

Each product page starts with a summary of the standard benefits and features of the range.

What fabric and colour?

Fabrics are grouped into price bands and priced individually for each product. On page 92 you will find a guide on choosing the right fabric for you and on our website we have a comprehensive fabric guide.

Fabric really does make a difference – both in terms of quality and rating and in terms of colour and design – so if you are in any doubt do call us to discuss your options. From our years of experience, we can recommend appropriate fabrics for certain seat types and environments and if we say we don't recommend a covering for a certain type of chair it is because we know it really does not work.

What price?

Order quantities have a huge impact on both manufacturing efficiency and logistics costs. It follows that **the more you order, the greater the level of discount we are able to offer** from our Recommended Retail Price. The discount structure we agree with you is our way of thanking you for your business and sharing the benefits of production and environmental efficiencies.

Ordering

You can email or post your orders. If you wish to place an order over the phone, we will ask you to confirm the details in writing as mistakes can be expensive for us all.

Please make sure you provide the product code, product size, any extras you wish to add and what finishes you require so we can make sure that what you receive is what you were expecting. Always add the price and don't forget we offer free delivery subject to the minimum order value and delivery location. We will provide you with an order acknowledgement as the final confirmation of your order details and this will form the basis of the contract for supply between us.

Deliveries

We hand-make all your furniture to order and we offer exceptionally quick deliveries, normally within 10 working days. All we ask is that you are ready for us. If for some reason you need to postpone delivery, please tell us as soon as you can so that we can stop making your products and won't have to charge you storage space.

We usually deliver on our own transport and to be effective we need to move on to our next customer, which may be you, quickly. Our drivers are not installation teams so we deliver to the ground floor point of entry. Please make sure you have appropriate staff on hand to accept delivery.

We take our environmental responsibilities seriously so do our best to reduce product miles and carbon footprint.

We are happy to quote for installation if this is a service you require.

Delivery charges

We do not charge for single drop deliveries of £750 and over within a specified list of postcodes which can be found on our website and are indicated within a red boundary line in the map on page 93. Deliveries within our boundary will be charged at £50 if the order value is below £750. Deliveries outside of the boundary will be charged at cost.

We regularly add to our portfolio so if you can't find exactly what you are looking for have a look at the website, or better still...

..call us. We are here to help.

01869 326300

Suggested Environments For Our Products

School, Colleges and Universities

Laptop Table	7
Wobble Stool	7
Arta	11
Hoxton	15
Kendra	16
Lisbon	17
Nova	19
Oregon	20
Silva - NEW	22
Horizon	23
Rama	23
The Booth	25
The Snug & Snuggle	27
Beanbag 2.0	29
Blockley	30
Kolbak	31
Stella	34
Zeta	35
Jupiter	45
Valbo	46
Beanbag	49
Dice and Cube	49
Toadstool	50
ZigZag	51
Century	55
Kingston	56
Mata	66
Prima	70
Prima Nest & Stack	71
Renza	72
5 Wave	73
FourStar	74
Trike	74
Primero	75
Mata Beam	84
Prima Beam	85

Student Accomodation

Laptop Table	7
Wobble Stool	7
Arta	11
Brompton - NEW	12
Hoxton - NEW	15
Kendra	16
Marna	18
Nova	19
Oregon	20
Silva - NEW	22
Horizon	23
Rama	23
The Booth	25
The Snug & Snuggle	27
Beanbag 2.0	29

Blockley	30
Kolbak	31
Stella	34
Zeta	35
Jupiter	45
Valbo	46
Toadstool	50
Century	55
Kingston	56
Mata	66
Prima	70
Prima Nest & Stack	71
Renza	72
5 Wave	73
Primero	75

Industrial & Technical

Laptop Table	7
Static Safe TechChair Bariatric use	60
Static Safe TechChair 24-hour use	63
FourStar Tablet Swivel	74
Saddle	77
TechChair & TechStools	78
PU TechChair & TechStools	79
Static Safe TechChair & TechStools	80
Static Safe & Sterile TechChair & TechStools	81
Medical Grade Clean Room	82
TechChair	

Hospitals, Healthcare and Care Homes

Arta	11
Hoxton	15
Kendra	16
Lisbon	17
Marna	18
Nova	19
Oregon	20
Raymon	21
Silva - NEW	22
Horizon	23
Rama	23
The Booth	25
Kolbak	31
Stella	34
Zeta	35
Jupiter	45
Valbo	46
Century	55
Kingston	56
Excelsior Range	60
Eon	63
Zenith	64

Mata	66
Prima	70
Prima Nest & Stack	71
Renza	72
5 Wave	73
Industrial & Technical range	77
Mata Beam	84
Prima Beam	85
Tala Beam	87

Office & Meeting Rooms

Laptop Table	7
Wobble Stool	7
Arta	11
Hoxton	15
Kendra	16
Lisbon	17
Marna	18
Nara	19
Nova	19
Oregon	20
Silva - NEW	22
Rama	23
Century	55
Kingston	56
Maran	57
Royce	58
24-hour Chairs	63
Mata	66
Mata Swivel	68
Prima	70
Renza	72

Public Spaces and Waiting Areas

Laptop Table	7
Wobble Stool	7
Arta	11
Brompton	12
Delaunay	13
Harlan - NEW	14
Hoxton	15
Kendra	16
Lisbon	17
Marna	18
Nara	19
Nova	19
Oregon	20
Raymon	21
Silva - NEW	22
Horizon	23
Rama	23
The Booth	25
The Snug & Snuggle	27

Index by Product Categories

Beanbag 2.0	29	Extras		Dice	49
Blockley	30	Laptop Table	7	Toadstool	50
Kolbak	31	Wobble Stool	7	ZigZag	51
Stella	34	Power Connections	7		
Zeta	35			Upholstry Services	
Jupiter	45	Soft Seating		Upholstry Services	53
Valbo	46	Scatter Cushions	9		
Mata Beam	84			Office, Task & Desk Chairs	
Prima Beam	85	Sofas, Armchairs & Lounge Chairs		Century	55
Tala Beam	87	Arta	11	Kingston	56
		Brompton - NEW	12	Maran	57
		Delaunay	13	Royce	58
		Harlan - NEW	14		
		Hoxton/ Hoxton Lux	15	Specialist Seating	
		Kendra/ Kendra Lux	16	Bariatric Chairs	
		Lisbon	17	Excelsior	60
		Marna	18	Excelsior Wood	61
		Nara	19		
		Nova	19	24-hour Chairs	
		Oregon	20	Eon	63
		Raymon	21	Zenith	64
		Silva - NEW	22		
		Horizon	23	Multipurpose	
		Rama	23	Mata	66
				Prima	70
		Booth Seating		Prima Nest & Stack	71
		The Booth	25	Renza	72
		The Snug & Snuggle	27	5 Wave	73
				FourStar	74
		Modular / Flexible Seating		Trike	74
		Beanbag 2.0	29	Primero	75
		Blockley	30		
		Kolbak	31	Industrial	
		Stella	34	Saddle & Perch	77
		Zeta	35	TechChair & TechStools	78
				PU TechChair & TechStool	79
		Stools		Static Safe TechChair & TechStools	80
		Jupiter	45	Static Safe & Sterile TechChair &	81
		Valbo	46	TechStools	
				Medical Grade Clean Room TechChair	82
		Seating for Kids			
		Beanbag	49	Beams	
		Cube	49	Mata Beam	84
				Prima Beam	85
				Tala Beam	87

Extras

We have a few items in the range that don't fit readily into any seating categories so we've grouped them in this Extras section.

Laptop Tables



These make perfect tables for use in a variety of environments and not just for laptops either. We are seeing them in break-out and lounge areas, staff rooms and student social areas, reception – in fact pretty much anywhere where a small height-adjustable surface is needed.

Product information

- Black or white top
- Other finishes available, please give us a call
- Black base
- Chrome base available at an upgrade price
- Height adjustable

Product Name	Product Code	Dimensions	Price
Laptop table	TAB/LAPTOP	H625-1050 W520 D380	£323

Wobble Stools



These height adjustable stools work anywhere from reception areas to offices, where the changes to working environments are seeing people sitting less but needing an occasional perch. The ball and socket mechanism at the base permits rotational movement which is a big plus for posture and general health.

Product information

- Grey fabric-upholstered seat
- Black steel column and base

Product Name	Product Code	Dimensions	Price
Wobble stool	STOOL/BALANCE	H590-850 W400 D400 SD300 SH590-850	£386

Power Connections

To further enhance the functionality of our soft seating, we can offer several of our ranges with power sockets built into the furniture and in the case of our booths the option of mounting the power module on the table is also available.

The power sockets for the furniture come in a variety of finishes and fit flush to the fabric to respect the overall appearance of the furniture and to help avoid snagging. They can provide Type A and C USB charging and fused UK or international sockets and in addition the on-desk units provide HDMI connectivity.

The units comply with BS 5733 and a choice of 3.15A and 5A fuses are available to comply with BS 6396. All standard options come with a 1 metre mains lead to a 3 pole connector.

We have also recently introduced the option of battery powered power connections that remove the requirement to site the seating units near to a mains power source.

Please enquire for prices and specific options/ recommendations.

Soft Seating

All our soft seating is designed and manufactured at our headquarters in Oxfordshire with the sustainability agenda always at the forefront of our design & manufacturing practices.

Our ranges include sofas and armchairs as well as families of modular seating, designed for style and comfort and to provide a solution for every type of setting.

- Our cores are made from FSC® certified board which gives them strength and durability.
- All our soft seating uses high density CMHR Crib 5 foams.

We are happy to manufacture to your requirements where non-standard dimensions or bespoke solutions are needed. Just call us to discuss.

Please note: References to right arm, left arm, right corner or left corner are from a seated position.

Power connections are available for many of our soft seating ranges – see Extras section for more details.





Scatter Cushions the finishing touch



Everyone knows what a difference the right selection of scatter cushions can make to any item of soft seating. We make a wide variety of scatter cushions to complement any of our soft seating ranges or just to buy on their own.

Sizes available: 400mm x 400mm and 500mm x 500mm.

Discount on orders in batches.

Product Name	Product Code	Fabric Groups						
		1	2	3	4	5	6	7
 Scatter Cushion 400mm x 400mm	CUSHION/400/1	£46	£48	£56	£63	£74	£91	£113
 Scatter Cushion 400mm x 400mm (batches of 3 in the same fabric)	CUSHION/400/3	£95	£100	£115	£130	£152	£186	£228
 Scatter Cushion 500mm x 500mm	CUSHION/500/1	£83	£88	£103	£118	£140	£174	£217
 Scatter Cushion 500 x 500 (batches of 2 in the same fabric)	CUSHION/500/2	£137	£143	£164	£185	£217	£263	£323



Sofas, Armchairs & Lounge Chairs

Rhubarb has created a broad range of sofas, armchairs and lounge chairs to cater for a wide variety of uses and styles.

Arta



Contemporary lounge chair for:

- Reception/ Break-Out
- Public spaces/ Waiting areas
- Offices & meeting rooms
- Café/ Dining/ Lounge areas
- Education, Training/ Conference Centres
- Student accommodation
- Healthcare

Product information:

- Side and armchair versions available
- Swivel, 4-Star, Sled or Wood bases available
- Upholstered in your choice of a wide range of fabric, leather, or vinyl

Product Name	Product Code	Dimensions	Fabric Groups						
			1	2	3	4	5	6	7
 Side Chair Swivel Round Base	ARTA/RO	H850 W600 D570 SD470 SH450	£775	£783	£811	£840	£883	£946	£1,027
 Arm Chair Swivel Round Base	ARTA/A/RO	H850 W600 D570 SD470 SH450	£843	£854	£887	£921	£973	£1,049	£1,146
 Side Chair 4-Star	ARTA/4	H850 W600 D570 SD470 SH450	£714	£722	£750	£779	£822	£885	£966
 Arm Chair 4-Star	ARTA/A/4	H850 W600 D570 SD470 SH450	£782	£793	£826	£860	£912	£988	£1,085
 Side Chair Sled	ARTA/SL	H850 W600 D570 SD470 SH450	£693	£702	£730	£758	£801	£865	£946
 Arm Chair Sled	ARTA/A/SL	H850 W600 D570 SD470 SH450	£762	£773	£806	£840	£892	£968	£1,065
 Side Chair Wood	ARTA/W	H850 W600 D570 SD470 SH450	£756	£765	£793	£821	£864	£927	£1,009
 Arm Chair Wood	ARTA/A/W	H850 W600 D570 SD470 SH450	£825	£835	£869	£903	£955	£1,030	£1,128

If fabrics in two or more different groups are used on one product it will be priced in the highest group. For any patterned or velvet fabrics a 10% surcharge is applied.

Brompton – New





New to the range this year, Brompton is a chunky contemporary armchair originally designed for a cinema room. Incredibly comfortable and available on either a swivel plate or with black bung feet.

- Leisure Venues
- Cinema Rooms
- Lounges/ Waiting Areas
- Public spaces
- Executive Offices

Product Information

- Swivel base or black bung feet
- Fibre back cushion
- Upholstered in your choice of a wide range of fabric, leather or vinyl

Product Name	Product Code	Dimensions	Fabric Groups						
			1	2	3	4	5	6	7
 Brompton Square Swivel Chair	BROMPTON/SQ	H900 W930 D930 SD590 SH450	£1,654	£1,688	£1,794	£1,902	£2,066	£2,306	£2,616
 Brompton Square	BROMPTON/SQ/ BUNG35	H900 W930 D930 SD590 SH450	£1,229	£1,262	£1,368	£1,476	£1,640	£1,881	£2,190

If fabrics in two or more different groups are used on one product it will be priced in the highest group. For any patterned or velvet fabrics a 10% surcharge is applied.

Delaunay





Art-Deco style sofa for anywhere a statement piece is called for:

- Reception/ Break out
- Public spaces/ waiting areas

Product Information

- Slim metal legs
- Webbed seat for comfort and durability
- Upholstered in your choice of a wide range of fabric, leather or vinyl
- Available as right or left hand chaise

Product Name	Product Code	Dimensions	Fabric Groups						
			1	2	3	4	5	6	7
 Delaunay Sofa (Left)	DELAUNAY/L	H880 W2220 D1240 SD630 SH450	£3,334	£3,385	£3,547	£3,711	£3,961	£4,328	£4,799
 Delaunay Sofa (Right)	DELAUNAY/R	H880 W2220 D1240 SD630 SH450	£3,334	£3,385	£3,547	£3,711	£3,961	£4,328	£4,799

If fabrics in two or more different groups are used on one product it will be priced in the highest group. For any patterned or velvet fabrics a 10% surcharge is applied.

Harlan - New



Stunning metal-frame lounge chair for any public areas where something of a statement is required.

- Leisure/ Hospitality
- Public spaces
- Executive offices
- Healthcare and private hospitals

Product Information

- Frame available in a variety of metal finishes
- Upholstered in your choice of a wide range of fabric, vinyl or leather

Product Name	Product Code	Dimensions	Fabric Groups						
			1	2	3	4	5	6	7
 Harlan Lounge Chair	HARLAN	H930 W1000 D800 SD580 SH430	£1,862	£1,874	£1,911	£1,949	£2,007	£2,092	£2,201

If fabrics in two or more different groups are used on one product it will be priced in the highest group. For any patterned or velvet fabrics a 10% surcharge is applied.

Hoxton and Hoxton Lux



Contemporary range, available with standard foams or with deep premium foams for high-end luxury and a focus on the ultimate in comfort:

- Reception/ Break-Out
- Public spaces/ waiting areas
- Lounge areas
- Executive offices
- Healthcare and private hospitals

Product Information

- Available as armchair, two-seater and three-seater sofa
- Loose seat and back cushions
- Reversible back cushions, fibre filled
- Wood legs but other options available, please enquire
- Webbed seat and back for enhanced comfort and durability
- Upholstered in your choice of a wide range of fabric, vinyl or leather

Product Name	Product Code	Dimensions	Fabric Groups						
			1	2	3	4	5	6	7
 Armchair	HOXTON1	H930 W1000 D800 SD587 SH430	£1,174	£1,200	£1,283	£1,367	£1,494	£1,682	£1,923
 Two-seater sofa	HOXTON2	H930 W1660 D800 SD587 SH430	£1,709	£1,748	£1,871	£1,996	£2,186	£2,465	£2,824
 Three-seater sofa	HOXTON3	H930 W2300 D800 SD587 SH430	£2,250	£2,302	£2,466	£2,632	£2,885	£3,255	£3,732
 Armchair - Lux Version	HOXTON1/LUX	H930 W1000 D800 SD587 SH430	£1,410	£1,441	£1,537	£1,636	£1,785	£2,004	£2,285
 Two-seater sofa - Lux Version	HOXTON2/LUX	H930 W1660 D800 SD587 SH430	£1,985	£2,029	£2,167	£2,308	£2,522	£2,837	£3,241
 Three-seater sofa - Lux version	HOXTON3/LUX	H930 W2300 D800 SD587 SH430	£2,614	£2,673	£2,857	£3,044	£3,328	£3,745	£4,281

If fabrics in two or more different groups are used on one product it will be priced in the highest group. For any patterned or velvet fabrics a 10% surcharge is applied.

Kendra and Kendra Lux







Stylish and superbly comfortable modern sofa available with standard foams or with deep premium quality foams for high-end luxury and a focus on the ultimate in comfort:

- Reception/ Break-Out
- Public spaces/ waiting areas
- Student accommodation
- Healthcare and private hospitals
- Offices
- Café/ Dining/ Lounge areas

Product Information

- Available as armchair, two-seater or three-seater sofa
- Loose seat cushions
- Wood legs
- Webbed seat for enhanced comfort and durability
- Upholstered in your choice of a wide range of fabric, vinyl or leather

Product Name	Product Code	Dimensions	Fabric Groups						
			1	2	3	4	5	6	7
 Armchair	KENDRA/1	H740 W1130 D825 SD600 SH415	£1,222	£1,248	£1,331	£1,415	£1,542	£1,730	£1,971
 Two-seater sofa	KENDRA/2	H740 W1730 D825 SD600 SH415	£1,664	£1,696	£1,796	£1,899	£2,054	£2,282	£2,575
 Three-seater sofa	KENDRA/3	H740 W2330 D825 SD600 SH415	£2,122	£2,163	£2,290	£2,420	£2,617	£2,906	£3,278
 Armchair - Lux Version	KENDRA/1/LUX	H740 W1130 D825 SD600 SH415	£1,504	£1,534	£1,627	£1,721	£1,865	£2,076	£2,346
 Two-seater sofa - Lux version	KENDRA/2/LUX	H740 W1730 D825 SD600 SH415	£2,052	£2,088	£2,201	£2,317	£2,491	£2,748	£3,078
 Three-seater sofa - Lux Version	KENDRA/3/LUX	H740 W2330 D825 SD600 SH415	£2,621	£2,667	£2,811	£2,957	£3,178	£3,504	£3,922

If fabrics in two or more different groups are used on one product it will be priced in the highest group. For any patterned or velvet fabrics a 10% surcharge is applied.

Lisbon







Sophisticated and stylish lounge chairs:

- Reception/ Break-Out
- Public spaces/ waiting areas
- Student accommodation
- Healthcare and private hospitals
- Offices
- Café/ Dining/ Lounge areas

Product Information

- Available as armchair or lounge chair
- Wood frame and legs
- Upholstered in your choice of a wide range of fabric, vinyl or leather
- Discounts available when batches are ordered in the same fabric and colour

Product Name	Product Code	Dimensions	Fabric Groups						
			1	2	3	4	5	6	7
 Armchair	LISBON/A	H810 W600 D520 SW520 SD460 SH470	£638	£647	£675	£704	£747	£810	£891
 Armchair - batches of 4	LISBON/A/4	H810 W600 D520 SW520 SD475 SH470	£632	£641	£667	£694	£735	£795	£872
 Lounge Chair	LISBON/L	H755 W570 D490 SW520 SD460 SH480	£562	£570	£595	£620	£659	£716	£789
 Lounge Chair - batches of 6	LISBON/L/6	H755 W570 D490 SW520 SD460 SH480	£548	£555	£575	£597	£629	£676	£737

If fabrics in two or more different groups are used on one product it will be priced in the highest group. For any patterned or velvet fabrics a 10% surcharge is applied.

Marna









Contemporary armchair and sofa:

- Reception/ Break-Out
- Public spaces/ waiting areas
- Offices
- Café/ Dining/ Lounge areas
- Student accommodation
- Healthcare and private hospitals

Product Information

- Chrome or wood legs
- Back available fluted or non-fluted (/NF)
- Webbed seat for enhanced comfort and durability
- Upholstered in your choice of a wide range of fabric, vinyl or leather

Product Name	Product Code	Dimensions	Fabric Groups						
			1	2	3	4	5	6	7
 Armchair	MARNA01	H650 W970 D850 SD610 SH420	£873	£896	£970	£1,045	£1,159	£1,326	£1,540
 Two-Seater Sofa	MARNA02	H650 W1580 D850 SD610 SH420	£1,246	£1,276	£1,371	£1,468	£1,615	£1,831	£2,108
 Three-Seater Sofa	MARNA03	H650 W2180 D850 SD610 SH420	£1,526	£1,563	£1,682	£1,803	£1,986	£2,254	£2,600
 Armchair	MARNA01/NF	H650 W970 D850 SD610 SH420	£881	£903	£973	£1,044	£1,152	£1,311	£1,515
 Two-Seater Sofa	MARNA02/NF	H650 W1580 D850 SD610 SH420	£1,187	£1,216	£1,310	£1,405	£1,549	£1,761	£2,033
 Three-Seater Sofa	MARNA03/NF	H650 W2180 D850 SD610 SH420	£1,457	£1,494	£1,611	£1,730	£1,910	£2,174	£2,515

If fabrics in two or more different groups are used on one product it will be priced in the highest group. For any patterned or velvet fabrics a 10% surcharge is applied.

Nara

Nova





Smart occasional sofa:

- Reception/ Break-Out
- Public spaces/ waiting areas
- Offices
- Café/ Dining/ Lounge areas

Product Information

- Wood legs
- Webbed seat for enhanced comfort and durability
- Upholstered in your choice of a wide range of fabric, vinyl or leather

	Product Name	Product Code	Dimensions
	Armchair	NARA/1	H830 W805 D770 SD575 SH435
	Two-Seater Sofa	NARA/2	H830 W1410 D770 SD575 SH435
	Three-Seater Sofa	NARA/3	H830 W2015 D770 SD575 SH435

Product Code	Fabric Groups						
	1	2	3	4	5	6	7
NARA/1	£945	£963	£1,021	£1,081	£1,171	£1,302	£1,472
NARA/2	£1,262	£1,289	£1,371	£1,455	£1,582	£1,769	£2,010
NARA/3	£1,600	£1,633	£1,738	£1,845	£2,008	£2,246	£2,552



If fabrics in two or more different groups are used on one product it will be priced in the highest group. For any patterned or velvet fabrics a 10% surcharge is applied.

Classic tub chair and sofa

- Reception/ Break-Out
- Schools, colleges
- Public spaces/ waiting areas
- Café/ Dining/ Lounge areas
- Student accommodation
- Healthcare and private hospitals

Product Information

- Chrome or wood legs
- Upholstered in wide range of fabric, vinyl or leather
- Exceptional strength & durability

	Product Name	Product Code	Dimensions
	Nova Tub Chair	NOVA/1	H800 W680 D680 SD470 SH450
	Nova Double	NOVA/2	H800 W1360 D680 SD470 SH450

Product Code	Fabric Groups						
	1	2	3	4	5	6	7
NOVA/1	£659	£673	£715	£758	£823	£918	£1,040
NOVA/2	£1,006	£1,026	£1,089	£1,153	£1,251	£1,394	£1,578

If fabrics in two or more different groups are used on one product it will be priced in the highest group. For any patterned or velvet fabrics a 10% surcharge is applied.

Oregon





Family of contemporary lounge chairs:

- Reception/ Break-Out
- Public spaces/ waiting areas
- Student accommodation
- Healthcare and private hospitals
- Offices
- Café/ Dining/ Lounge areas

Product Information

- Available as armchair, lounge chair or high stool
- Wood frame and legs
- Upholstered in your choice of a wide range of fabric, vinyl or leather

Product Name	Product Code	Dimensions	Fabric Groups						
			1	2	3	4	5	6	7
 Side Chair	OREGON/S	H845 W500 D560 SH460	£564	£571	£590	£610	£640	£684	£741
 Arm Chair	OREGON/A	H810 W500 D590 SH450	£636	£643	£664	£685	£717	£765	£826
 High Stool	OREGON/H	H1055 W510 D500 SH740	£649	£656	£677	£698	£731	£778	£839

If fabrics in two or more different groups are used on one product it will be priced in the highest group. For any patterned or velvet fabrics a 10% surcharge is applied.

Raymon







Traditional high back armchair with either winged or straight back, now adapted to be suitable for orthopedic use:

- Care Homes
- Healthcare and private hospitals
- Reception/ Break-Out
- Public spaces/ waiting areas
- Lounge areas

Product Information

- Different seat heights available for care home and orthopedic use to ensure comfort for each individual and ease of sitting and standing
- Optional button detail to upholstery on back (not recommended in vinyl)
- Webbed seat for comfort and durability
- Upholstered in your choice of a wide range of fabric, vinyl or leather

Product Name	Product Code	Dimensions	Fabric Groups						
			1	2	3	4	5	6	7
 Arm Chair	RAYMON	H1115 W740 D785 SD560 SH500	£1,277	£1,308	£1,407	£1,508	£1,660	£1,884	£2,172
 Winged Armchair	RAYMON/W	H1260 W740 D785 SD560 SH500	£1,401	£1,436	£1,548	£1,661	£1,833	£2,085	£2,410
 Arm Chair - No Buttoning Detail	RAYMON/NB	H1115 W740 D785 SD560 SH500	£1,234	£1,265	£1,364	£1,464	£1,617	£1,841	£2,129
 Winged Armchair - No Buttoning Detail	RAYMON/W/ NB	H1260 W740 D785 SD560 SH500	£1,350	£1,385	£1,496	£1,610	£1,782	£2,034	£2,359

If fabrics in two or more different groups are used on one product it will be priced in the highest group. For any patterned or velvet fabrics a 10% surcharge is applied.

Silva - New







Clean simplicity makes this small family of lounge chairs an ideal choice for a variety of settings and environments:

- Hospitality
- Public spaces/ waiting areas
- Meeting rooms/ Offices

Product Information

- Range includes side chair, armchair, high stool and two-seater sofa
- Upholstered in your choice of a wide range of fabric, vinyl or leather

Product Name	Product Code	Dimensions	Fabric Groups						
			1	2	3	4	5	6	7
 Armchair	SILVA/A/CHAIR	H810 W650 D550 SD450 SH450	£600	£610	£642	£675	£725	£799	£893
 Side Chair	SILVA/CHAIR	H810 W650 D550 SD450 SH450	£550	£559	£588	£618	£663	£729	£813
 High Stool	SILVA/STOOL	H1070 W550 D550 SD450 SH760	£699	£707	£733	£759	£799	£858	£933
 Two-seater Sofa	SILVA/SOFA2	H810 W1370 D550 SD450 SH450	£1,080	£1,095	£1,144	£1,193	£1,268	£1,378	£1,519

If fabrics in two or more different groups are used on one product it will be priced in the highest group. For any patterned or velvet fabrics a 10% surcharge is applied.

Horizon





Armchairs with solid natural beech frame

- Hospital Wards and Waiting Areas
- Medical Waiting Rooms
- Care homes
- Schools, Colleges, Student accommodation

Product Information

- Available as armchair and high back armchair
- Upholstered in fabric, leather or vinyl
- High density CMHR foam
- Solid natural beech wood frame

	Product Name	Product Code	Dimensions
	Chair with Arms	HORIZON/1/A	H800 W580 D650 SH450
	High Back Chair with Arms	HORIZON1/A/HB	H1175 W640 D680 SH490
	High Back Chair with Arms on wheels	HORIZON1/A/HB/W	H1125 W640 D680 SH490

Product Code	Fabric Groups						
	1	2	3	4	5	6	7
HORIZON/1/A	£596	£604	£631	£657	£698	£758	£835
HORIZON1/A/HB	£569	£577	£600	£624	£660	£714	£782
HORIZON1/A/HB/W	£588	£595	£619	£643	£679	£732	£801

If fabrics in two or more different groups are used on one product it will be priced in the highest group. For any patterned or velvet fabrics a 10% surcharge is applied.

Rama





A version of our popular Nova rub range specifically designed for the contract market

- Schools, Colleges, Student accommodation
- Waiting rooms
- Public spaces
- Café/dining/lounge areas
- Staff rooms

Product Information

- Black bung feet
- Upholstered in your choice of a wide range of fabric, vinyl or leather

	Product Name	Product Code	Dimensions
	Rama Tub Chair	RAMA/1	H775 W720 D635 SD540 SH460
	Rama Double	RAMA/2	H775 W1390 D635 SD540 SH460

Product Code	Fabric Groups						
	1	2	3	4	5	6	7
RAMA/1	£436	£449	£490	£532	£595	£689	£809
Rama Tub Chair BATCHES OF TWO (in same fabric only)	£409	£421	£460	£499	£558	£644	£756
RAMA/2	£772	£796	£869	£944	£1,057	£1,224	£1,483

If fabrics in two or more different groups are used on one product it will be priced in the highest group. For any patterned or velvet fabrics a 10% surcharge is applied.

Booth Seating

Booth Seating has become increasingly popular for all manner of settings and environments from waiting areas to restaurants, libraries to colleges and schools. Most important, these rages can be made to your specific dimensions for height, depth and width.

The Booth







Fully upholstered booth and definitely one of our most versatile ranges, made to measure when required and available with a variety of stitching finishes to the back:

- Break-out areas
- Public spaces
- Schools
- Student accommodation
- Café/ Dining/ Lounge areas
- Staff rooms

Product Information

- Thin plinth as an option in a variety of standard finishes
- Bespoke dimensions available to suit specific project needs, please enquire
- Upholstered in your choice of a wide range of fabric, leather, or vinyl
- 2-Seater Medium and High Back, 3-Seater Medium and High Back

Product Name	Product Code	Dimensions	Fabric Groups						
			1	2	3	4	5	6	7
 Two-seater booth Medium Back	BOOTH/MB/2	H1000 W1200 D750 SD550 SH500	£869	£892	£964	£1,038	£1,150	£1,314	£1,525
 Two-seater booth High Back	BOOTH/HB/2	H1200 W1200 D750 SD550 SH500	£926	£952	£1,031	£1,111	£1,234	£1,413	£1,644
 Three-seater booth Medium Back	BOOTH/MB/3	H1000 W1800 D750 SD550 SH500	£1,245	£1,278	£1,382	£1,489	£1,650	£1,887	£2,191
 Three-seater booth High Back	BOOTH/HB/3	H1200 W1800 D750 SD550 SH500	£1,298	£1,334	£1,447	£1,562	£1,736	£1,992	£2,321

If fabrics in two or more different groups are used on one product it will be priced in the highest group. For any patterned or velvet fabrics a 10% surcharge is applied.



The Booth

Full details of the range are on page 25. Contract pricing is available for single orders of more than 50 units.



The Snug and the Snuggle





Create a private meeting or study space with our cosy single snuggle or double snug booth:

- Break-out areas
- Café/ Lounge areas
- Public spaces/ waiting areas

Product Information

- Bespoke dimensions available to suit specific project needs, please enquire
- Black bung feet
- Upholstered in your choice of a wide range of fabric, leather, or vinyl
- Available with connecting screen and table to create double booth

Product Name	Product Code	Dimensions	Fabric Groups						
			1	2	3	4	5	6	7
 Large Single Snuggle Booth	SNUGGLE	H1733 W1200 D718 SD541 SH500	£2,234	£2,312	£2,554	£2,801	£3,176	£3,725	£4,432
 Double Snug Booth	SNUG	H1733 W1800 D718 SD541 SH500	£3,247	£3,360	£3,716	£4,078	£4,627	£5,433	£6,470

If fabrics in two or more different groups are used on one product it will be priced in the highest group. For any patterned or velvet fabrics a 10% surcharge is applied.

Modular/ Flexible Seating

Rhubarb has a large range of modular seating units to permit multiple different configurations and enable the use of space to be maximized. Because we manufacture everything ourselves, we are also able to change the dimensions of any unit to fit either specific design requirements or room measurements. As with all our soft seating, our modular units are designed and manufactured at our Oxfordshire factory using FSC® certified board and high density CMHR Crib 5 foams

Beanbag 2.0



An all-season classic re-invented in larger format and new shape to provide real comfort and support:

- Student accommodation
- Lounge/ café areas
- Adult break-out areas

Product information

- Removable cover
- Polystyrene beans in sealed inner liner
- Upholstered in your choice of a wide range of fabric, leather or vinyl
- 12-Month manufacturing warranty

Product Name	Product Code	Dimensions	Fabric Groups						
			1	2	3	4	5	6	7
 Beanbag 2.0	BEANBAG 2.0	DIA850	£293	£306	£347	£389	£453	£546	£666

If fabrics in two or more different groups are used on one product it will be priced in the highest group. For any patterned or velvet fabrics a 10% surcharge is applied.



Blockley







All types of spaces benefit from the flexibility of these modular seating units:

- School, university and college settings
- Student accommodation
- Public spaces/ waiting areas
- Reception
- Break out

Send us the room plan and outline requirements and we will provide a **suggested layout**.

Product information:

- 4 standard elements (each priced separately)
- Upholstered in your choice of a wide range of fabric, vinyl or leather
- Bespoke dimensions available to suit specific project needs, please enquire

Product Name	Product Code	Dimensions	Fabric Groups						
			1	2	3	4	5	6	7
 Two Tier Block	BLOCKLEY/2TIER	H950 W1200 D1200	£959	£991	£1,091	£1,194	£1,349	£1,577	£1,870
 Three Tier Block	BLOCKLEY/3TIER	H950 W1200 D1200	£1,093	£1,125	£1,224	£1,324	£1,477	£1,701	£1,989
 Inside Block	BLOCKLEY/ INSIDE	H950 W1200 D1200	£1,086	£1,122	£1,233	£1,346	£1,518	£1,771	£2,095
 Outside Block	BLOCKLEY/ OUTSIDE	H950 W1200 D1200	£862	£891	£981	£1,072	£1,211	£1,414	£1,676

If fabrics in two or more different groups are used on one product it will be priced in the highest group. For any patterned or velvet fabrics a 10% surcharge is applied.

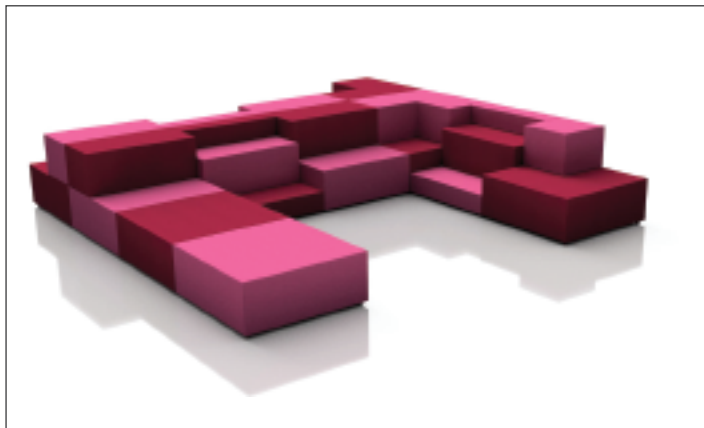

Kolbak – LOW













Fully modular seating system with straight and curved units in low, medium or high back, to accommodate a wide variety of uses and settings.

- Reception/ Break-Out
- Student Accommodation
- Public Spaces/ waiting areas
- Café/ lounge spaces

Product Information

- Power supply can be provided, please enquire
- Chrome or wood legs
- Webbed seat for enhanced comfort and durability
- Upholstered in your choice of a wide range of fabric, vinyl or leather
- Table top options available, please enquire
- Fluting option is available on backs of all units – low, medium and high – please enquire

Product Name	Product Code	Dimensions	Fabric Groups						
			1	2	3	4	5	6	7
 Low Back Single	KOL/LB/S	H825 W570 D780 SD560 SH470	£575	£588	£629	£671	£735	£829	£949
 Low Back Single Corner Right	KOL/LB/S/R	H825 W795 D780 SD560 SH470	£863	£883	£949	£1,015	£1,116	£1,264	£1,455
 Low Back Single Corner Left	KOL/LB/S/L	H825 W795 D780 SD560 SH470	£863	£883	£949	£1,015	£1,116	£1,264	£1,455
 Low Back Double	KOL/LB/D	H825 W1110 D780 SD560 SH470	£841	£861	£922	£986	£1,081	£1,222	£1,402
 Low Back Double Corner Right	KOL/LB/D/R	H825 W1335 D780 SD560 SH470	£1,016	£1,043	£1,127	£1,213	£1,343	£1,534	£1,780
 Low Back Double Corner Left	KOL/LB/D/L	H825 W1335 D780 SD560 SH470	£1,016	£1,043	£1,127	£1,213	£1,343	£1,534	£1,780
 Low Back Single Pod	KOL/LB/S/LR	H825 W1020 D780 SD560 SH470	£1,035	£1,062	£1,146	£1,232	£1,362	£1,553	£1,799
 Low Back Double Pod	KOL/LB/D/LR	H825 W1560 D780 SD560 SH470	£1,148	£1,177	£1,266	£1,357	£1,496	£1,698	£1,959
 Low Back Round	KOL/LB/RND	H825 W1150 D840 SD560 SH470	£897	£971	£983	£1,049	£1,150	£1,298	£1,489
 Low Back Screen	KOL/LB/POD/ PANEL	H825 W1080 D SD SH	£329	£336	£360	£385	£422	£477	£547
 Round Base Unit	KOL/RND	H470 W1230 D860	£778	£799	£864	£931	£1,032	£1,180	£1,370

If fabrics in two or more different groups are used on one product it will be priced in the highest group. For any patterned or velvet fabrics a 10% surcharge is applied.

Kolbak – Medium













Fully modular seating system with straight and curved units in low, medium or high back, to accommodate a wide variety of uses and settings.

- Reception/ Break-Out
- Student Accommodation
- Public Spaces/ waiting areas
- Café/ lounge spaces

Product Information

- Power supply can be provided, please enquire
- Chrome or wood legs
- Webbed seat for enhanced comfort and durability
- Upholstered in your choice of a wide range of fabric, vinyl or leather
- Table top options available, please enquire
- Fluting option is available on backs of all units – low, medium and high – please enquire

Product Name	Product Code	Dimensions	Fabric Groups						
			1	2	3	4	5	6	7
 Medium Back Single	KOL/MB/S	H1230 W570 D780 SD560 SH470	£623	£638	£686	£735	£810	£919	£1,059
 Medium Back Single Corner Right	KOL/MB/S/R	H1230 W795 D780 SD560 SH470	£951	£976	£1,055	£1,136	£1,258	£1,438	£1,668
 Medium Back Single Corner Left	KOL/MB/S/L	H1230 W795 D780 SD560 SH470	£951	£976	£1,055	£1,136	£1,258	£1,438	£1,668
 Medium Back Double	KOL/MB/D	H1230 W1110 D780 SD560 SH470	£914	£939	£1,016	£1,095	£1,215	£1,390	£1,616
 Medium Back Double Corner Right	KOL/MB/D/R	H1230 W1335 D780 SD560 SH470	£1,170	£1,197	£1,283	£1,370	£1,503	£1,698	£1,949
 Medium Back Double Corner Left	KOL/MB/D/L	H1230 W1335 D780 SD560 SH470	£1,170	£1,197	£1,283	£1,370	£1,503	£1,698	£1,949
 Medium Back Single Pod	KOL/MB/S/LR	H1230 W1020 D780 SD560 SH470	£1,090	£1,122	£1,223	£1,327	£1,483	£1,714	£2,009
 Medium Back Double Pod	KOL/MB/D/LR	H1230 W1560 D780 SD560 SH470	£1,314	£1,348	£1,455	£1,563	£1,728	£1,970	£2,281
 Medium Back Round	KOL/MB/RND	H1230 W1150 D840 SD560 SH470	£1,150	£1,179	£1,270	£1,363	£1,504	£1,710	£1,976
 Medium Back Screen	KOL/MB/POD/ PANEL	H1230 W1080 D SD SH	£424	£440	£488	£537	£611	£720	£861

If fabrics in two or more different groups are used on one product it will be priced in the highest group. For any patterned or velvet fabrics a 10% surcharge is applied.

Kolbak – High











Fully modular seating system with straight and curved units in low, medium or high back, to accommodate a wide variety of uses and settings.

- Reception/ Break-Out
- Student Accommodation
- Public Spaces/ waiting areas
- Café/ lounge spaces

Product Information

- Power supply can be provided, please enquire
- Chrome or wood legs
- Webbed seat for enhanced comfort and durability
- Upholstered in your choice of a wide range of fabric, vinyl or leather
- Table top options available, please enquire
- Fluting option is available on backs of all units – low, medium and high – please enquire

Product Name	Product Code	Dimensions	Fabric Groups						
			1	2	3	4	5	6	7
 High Back Single Corner Right	KOL/HB/S/R	H1650 W795 D780 SD560 SH470	£1,292	£1,330	£1,449	£1,570	£1,753	£2,022	£2,368
 High Back Single Corner Left	KOL/HB/S/L	H1650 W795 D780 SD560 SH470	£1,292	£1,330	£1,449	£1,570	£1,753	£2,022	£2,368
 High Back Double Corner Right	KOL/HB/D/R	H1650 W1335 D780 SD560 SH470	£1,574	£1,615	£1,744	£1,876	£2,075	£2,367	£2,743
 High Back Double Corner Left	KOL/HB/D/L	H1650 W1335 D780 SD560 SH470	£1,574	£1,615	£1,744	£1,876	£2,075	£2,367	£2,743
 High Back Single Pod	KOL/HB/S/LR	H1650 W1020 D780 SD560 SH470	£1,475	£1,514	£1,634	£1,757	£1,943	£2,216	£2,567
 High Back Double Pod	KOL/HB/D/LR	H1650 W1560 D780 SD560 SH470	£2,031	£2,083	£2,246	£2,412	£2,665	£3,035	£3,511
 High Back Round	KOL/HB/RND	H1650 W1150 D840 SD560 SH470	£1,307	£1,341	£1,448	£1,557	£1,721	£1,963	£2,274
 High Back Connecting Screen	KOL/HB/POD/PANEL	H1650 W1080 D SD SH	£668	£691	£765	£840	£955	£1,122	£1,338

If fabrics in two or more different groups are used on one product it will be priced in the highest group. For any patterned or velvet fabrics a 10% surcharge is applied.

Stella













Compact modular seating ideal for small and large projects with a huge variety of possible configurations:

- Reception/ Break-Out
- Staff Rooms
- Student accommodation
- Hospital Wards and Waiting Areas
- Medical Waiting Rooms
- Care homes

Product Information

- Wide variety of double, single, straight, curved and corner units
- Black bung feet
- Castors on front of ST5 and ST6 option for additional moveability
- Webbed seat for comfort and durability
- Upholstered in your choice of a wide range of fabric, vinyl or leather

Product Name	Product Code	Dimensions	Fabric Groups						
			1	2	3	4	5	6	7
 Single Curved Unit	ST2	H750 W790 D730 SD450 SH430	£476	£489	£531	£574	£639	£734	£857
 1500 Curved Unit	ST4	H750 W1520 D720 SD450 SH430	£904	£925	£993	£1,062	£1,167	£1,321	£1,519
 500 Unit	ST5	H750 W520 D720 SD450 SH430	£457	£469	£506	£544	£602	£686	£794
 500 Unit on Castors	ST5/C	H750 W520 D720 SD450 SH430	£459	£471	£508	£546	£603	£687	£796
 600 Plus Unit	ST6	H750 W620 D720 SD450 SH430	£485	£497	£538	£579	£641	£733	£851
 600 Plus Unit on Castors	ST6/C	H750 W620 D720 SD450 SH430	£488	£501	£541	£582	£644	£736	£854
 45 degree Angled Unit	ST7	H750 W710 D720 SD450 SH430	£458	£467	£496	£526	£571	£637	£722
 90 degree Corner Unit	ST8	H750 W720 D720 SD450 SH430	£657	£674	£728	£782	£864	£985	£1,141
 Corner Unit Plus	ST10	H750 W920 D920 SD450 SH430	£781	£804	£879	£954	£1,069	£1,238	£1,455
 Curved Corner Unit	ST11	H750 W930 D720 SD450 SH430	£494	£508	£553	£599	£669	£722	£904
 Double Unit Chair 1200	ST12	H750 W1200 D720 SD450 SH430	£695	£713	£771	£831	£920	£1,052	£1,222

If fabrics in two or more different groups are used on one product it will be priced in the highest group. For any patterned or velvet fabrics a 10% surcharge is applied.

Zeta – Standard Units

Fully modular seating for flexible configuration, with standard, curved and corner units. Ideal for small and large projects

- Reception/ Break-Out
- School, College, University
- Student accommodation
- Café/ Dining/ Lounge Areas

Please note: references to right arm, left arm, right corner or left corner are from a seated position

Product Information

- 5 standard constituent elements:
 - Single
 - Double
 - Back, single or double
 - Corner, left and/ or right
 - Arm, left and/ or right
- Elements can be configured to suit any environment and space
- Webbed seat for comfort and durability
- Chrome or wood legs
- Upholstered in your choice of a wide range of fabric, leather or vinyl
- Dimensions can be altered to meet individual project needs, please enquire



Single ZETA1



Double ZETA2



Single back ZETA1/B



Double back ZETA2/2B



Right corner ZETA1/CO



Both corner ZETA2/LC/RC



Left corner ZETA2/B/LC



Right arm ZETA1/B/RA



Both arms ZETA1/B/RA/LA



Left arm ZETA2/2B/LA

Zeta – Standard Single Units









Fully modular seating for flexible configuration, with standard, curved and corner units. Ideal for small and large projects.

- Reception/ Break-Out
- School, College, University
- Student accommodation
- Café/ Dining/ Lounge Areas

Product Information

- Elements can be configured to suit any environment and space
- Webbed seat for comfort and durability
- Chrome or wood legs
- Upholstered in your choice of a wide range of fabric, leather or vinyl
- Dimensions can be altered to meet individual project needs, please enquire

The following configurations are available for Zeta single units:

Product Name	Product Code	Dimensions	Fabric Groups						
			1	2	3	4	5	6	7
 Single Unit	ZETA1	H425 W665 D665 SH425	£325	£333	£355	£378	£413	£465	£531
 Single Unit with Back	ZETA1/B	H770 W665 D665 SD510 SH425	£435	£443	£471	£499	£541	£603	£684
 Single Unit with Corner	ZETA1/CO	H770 W665 D665 SD510 SH425	£465	£477	£514	£552	£610	£694	£802
 Single Unit with Back and Left or Right Arm	ZETA1/B/LA or ZETA1/B/RA	H770 W765 D665 SD510 SH425	£555	£568	£608	£649	£712	£803	£921
 Single Unit with Back and Left and Right Arms	ZETA1/B/LA/RA	H770 W865 D665 SD510 SH425	£678	£695	£749	£803	£885	£1,006	£1,162
 Single Corner Unit	ZETA930C	H770 W930 D665 SH425	£761	£778	£831	£886	£968	£1,089	£1,245

If fabrics in two or more different groups are used on one product it will be priced in the highest group. For any patterned or velvet fabrics a 10% surcharge is applied.

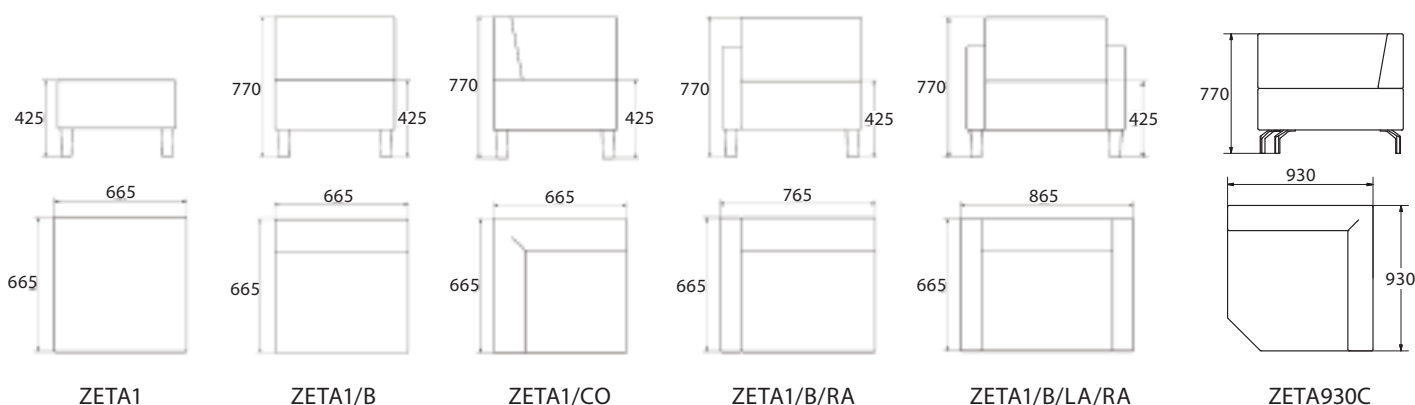

Zeta – Standard Double Units





Fully modular seating for flexible configuration, with standard, curved and corner units. Ideal for small and large projects.

- Reception/ Break-Out
- School, College, University
- Student accommodation
- Café/ Dining/ Lounge Areas

Product Information

- Elements can be configured to suit any environment and space
- Webbed seat for comfort and durability
- Chrome or wood legs
- Upholstered in your choice of a wide range of fabric, leather or vinyl
- Dimensions can be altered to meet individual project needs, please enquire

The following configurations are available for Zeta double units:

Product Name	Product Code	Dimensions	Fabric Groups						
			1	2	3	4	5	6	7
 Double Unit	ZETA2	H425 W1315 D665 SH425	£478	£489	£523	£557	£610	£687	£786
 Double Unit with Single Back	ZETA2/1B	H770 W1315 D665 SD510 SH425	£563	£575	£614	£653	£713	£801	£914
 Double Unit with Double Back	ZETA2/2B	H770 W1315 D665 SD510 SH425	£667	£685	£742	£800	£887	£1,015	£1,180
 Double Unit with Left or Right Corner	ZETA2/LC or ZETA2/RC	H770 W1315 D665 SH425	£722	£737	£782	£828	£898	£1,001	£1,133

If fabrics in two or more different groups are used on one product it will be priced in the highest group. For any patterned or velvet fabrics a 10% surcharge is applied.

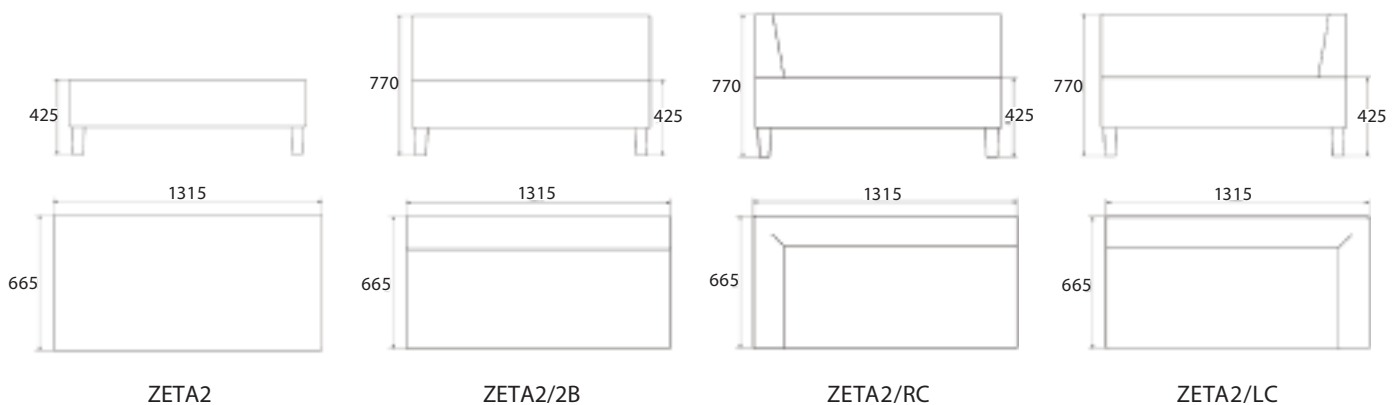

Zeta – Standard Double Units







Fully modular seating for flexible configuration, with standard, curved and corner units. Ideal for small and large projects.

- Reception/ Break-Out
- School, College, University
- Student accommodation
- Café/ Dining/ Lounge Areas

Product Information

- Elements can be configured to suit any environment and space
- Webbed seat for comfort and durability
- Chrome or wood legs
- Upholstered in your choice of a wide range of fabric, leather or vinyl
- Dimensions can be altered to meet individual project needs, please enquire

The following configurations are available for Zeta double units:

Product Name	Product Code	Dimensions	Fabric Groups						
			1	2	3	4	5	6	7
 Double Unit with Back and Left or Right Corner	ZETA2/B/LC or ZETA2/B/RC	H770 W1315 D665 SD510 SH425	£769	£787	£842	£898	£983	£1,107	£1,268
 Double Unit with Left and Right Corners	ZETA2/LC/RC	H770 W1315 D665 SD510 SH425	£849	£870	£938	£1,007	£1,112	£1,266	£1,464
 Double Unit with Double Back and Left or Right Arm	ZETA2/2B/LA or ZETA2/2B/RA	H770 W1415 D665 SD510 SH425	£790	£809	£869	£930	£1,022	£1,158	£1,332
 Double Unit with Double Back and Left and Right Arms	ZETA2/2B/LA/RA	H770 W1515 D665 SD510 SH425	£915	£939	£1,013	£1,089	£1,203	£1,372	£1,589

If fabrics in two or more different groups are used on one product it will be priced in the highest group. For any patterned or velvet fabrics a 10% surcharge is applied.

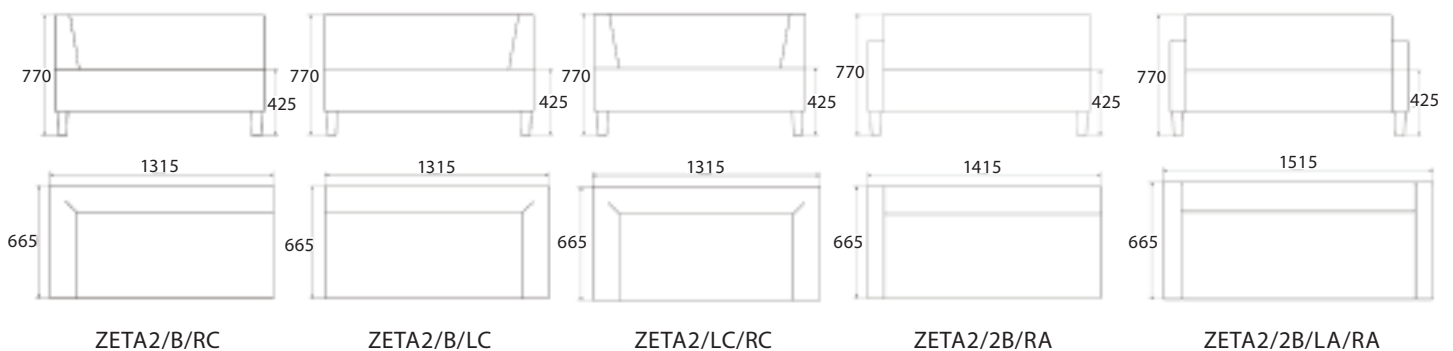

Zeta – Curved, Corner and Pod Units

Fully modular seating for flexible configuration, with standard, curved and corner units

- Reception/ Break-Out
- School, College, University
- Student accommodation
- Café/ Dining/ Lounge Areas

Product Information

- Webbed seat for comfort and durability
- Chrome or wood legs
- Upholstered in your choice of a wide range of fabric or leather
- Dimensions can be altered to meet individual project needs, please enquire



45 Degree Curve
ZETAC45



90 Degree Curve
ZETAC90



Quarter Segment ZETAQ



Half Segment ZETAH



45 Degree Curve with Back
ZETAC45/B



90 Degree Curve with Back
ZETAC90/B



Half Segment with Back ZETAH/B



NEW 90 Degree Curve with Inside Back
ZETA90/IB



ZETA2/POD

Zeta – Curved Units







Fully modular seating for flexible configuration, with standard, curved and corner units.

- Reception/ Break-Out
- School, College, University
- Student accommodation
- Café/ Dining/ Lounge Areas

Product Information

- Elements can be configured to suit any environment and space.
- Webbed seat for comfort and durability
- Chrome or wood legs
- Upholstered in your choice of a wide range of fabric or leather
- Dimensions can be altered to meet individual project needs, please enquire

The following configurations are available for Zeta curved units:

Product Name	Product Code	Dimensions	Fabric Groups						
			1	2	3	4	5	6	7
 45 Degree Curve	ZETAC45	H425 W920 D740 SH425	£440	£448	£472	£497	£534	£589	£660
 45 Degree Curve with Back	ZETAC45/B	H770 W920 D740 SH425	£582	£594	£631	£669	£726	£810	£919
 90 Degree Curve	ZETAC90	H425 W1650 D830 SH425	£716	£730	£772	£815	£879	£975	£1,097
 90 Degree Curve with Back	ZETAC90/B	H770 W1650 D830 SH425	£986	£1,009	£1,082	£1,156	£1,268	£1,433	£1,645
 90 Degree Curve with Inside Back	ZETA90/IB	H770 W1650 D830 SH425	£900	£919	£979	£1,040	£1,132	£1,268	£1,442

If fabrics in two or more different groups are used on one product it will be priced in the highest group. For any patterned or velvet fabrics a 10% surcharge is applied.

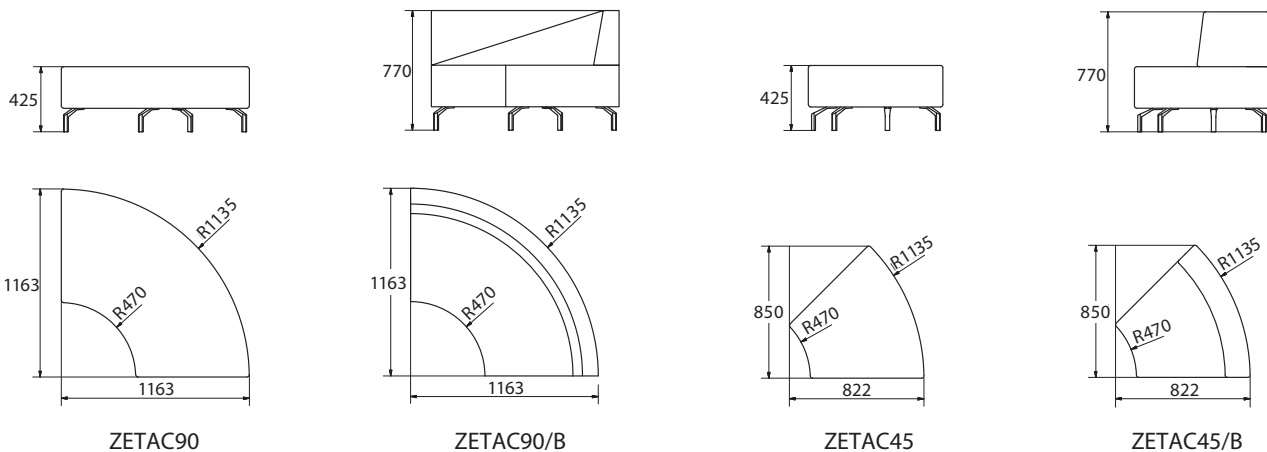

Zeta – Curved Units





Fully modular seating for flexible configuration, with standard, curved and corner units.

- Reception/ Break-Out
- School, College, University
- Student accommodation
- Café/ Dining/ Lounge Areas

Product Information

- Elements can be configured to suit any environment and space.
- Webbed seat for comfort and durability
- Chrome or wood legs
- Upholstered in your choice of a wide range of fabric or leather
- Dimensions can be altered to meet individual project needs, please enquire

The following configurations are available for Zeta curved units:

Product Name	Product Code	Dimensions	Fabric Groups						
			1	2	3	4	5	6	7
 Quarter Segment	ZETAQ	H425 W665 D665 SH425	£384	£390	£410	£429	£459	£503	£560
 Half Segment	ZETAH	H425 W1320 D665 SH425	£612	£624	£659	£695	£750	£831	£935
 Half Segment with Back	ZETAH/B	H770 W1320 D665 SH425	£716	£730	£774	£818	£886	£985	£1,112

If fabrics in two or more different groups are used on one product it will be priced in the highest group. For any patterned or velvet fabrics a 10% surcharge is applied.

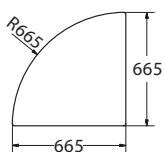
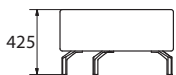

ZETAQ

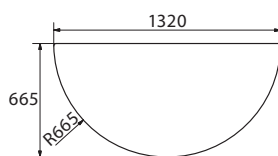

ZETAH

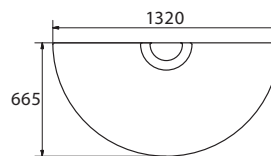
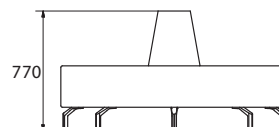

ZETAH/B

Zeta – Pod



- Reception/ Break-Out
- School, College, University
- Student accommodation
- Café/ Dining/ Lounge Areas

Product Information

Zeta Pod can be designed to suit any environment and space

- Webbed seat for comfort and durability
- Chrome or wood legs
- Upholstered in your choice of a wide range of fabric or leather
- Dimensions can be altered to meet individual project needs, please enquire

Product Name	Product Code	Dimensions	Fabric Groups						
			1	2	3	4	5	6	7
 Double Pod	ZETA2/POD	H1340 W1360 D690 SD510 SH425	£1,329	£1,371	£1,502	£1,635	£1,837	£2,134	£2,516

If fabrics in two or more different groups are used on one product it will be priced in the highest group. For any patterned or velvet fabrics a 10% surcharge is applied.

Some examples of Zeta Pod designs:



Zeta Jigsaw



Zeta Pod with roof baffles



Zeta Pod

Zeta

The breadth, versatility and robustness of our Zeta range makes it an obvious choice for large-scale projects. For example, we recently manufactured around 300 units for a new student accommodation development and that was typical of the use and volumes for which it is ideally suited.

Full details of the range are on pages 33 to 40. Contract pricing is available for single orders of more than 50 units.



Stools

Stools provide the perfect solution to flexible seating requirements in all sorts of environments. Not only does Rhubarb have a wide variety of shapes and sizes available but many of them have polystyrene cores making them super-light and easy to move around.

Jupiter





Lightweight but robust round stool with polystyrene core and chrome legs

- School, College, University, Student accommodation
- Reception/ Break-Out

Product Information

- Polystyrene core reduces weight
- Chrome or wooden legs available
- Upholstered in your choice of a wide range of fabric, leather or vinyl

Product Name	Product Code	Dimensions	Fabric Groups						
			1	2	3	4	5	6	7
 Jupiter Single Low Stool	JUP1	H460 W680 D560	£309	£314	£331	£348	£374	£413	£462
 Jupiter Double Low Stool	JUP2	H460 W1100 D680	£396	£404	£431	£457	£498	£557	£633

If fabrics in two or more different groups are used on one product it will be priced in the highest group. For any patterned or velvet fabrics a 10% surcharge is applied.

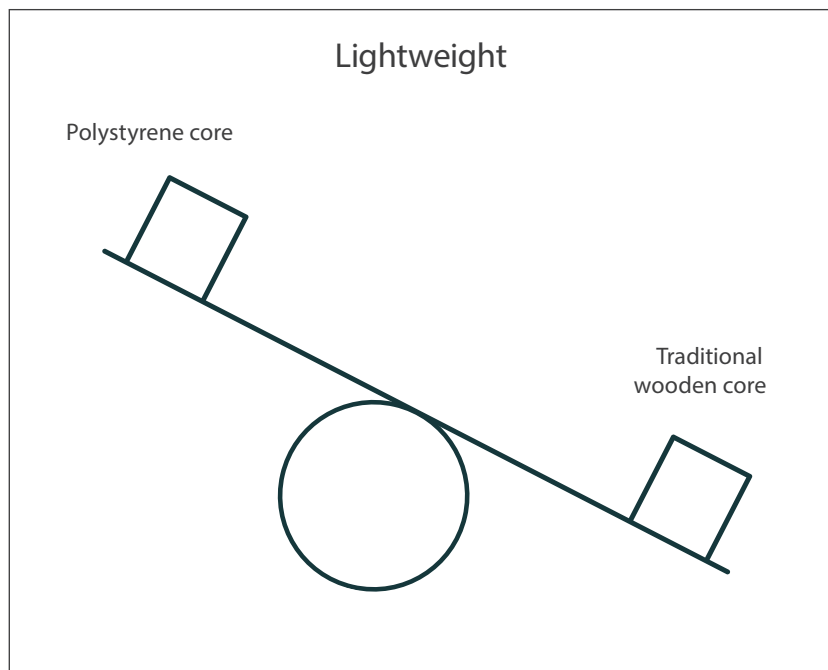

Valbo









Lightweight range of stools, most with polystyrene cores making them extremely easy to move around as required:

- Schools, Colleges, Student accommodation
- Reception/ Break-Out
- Libraries

Product Information

- Black feet
- Upholstered in your choice of a wide range of fabric, leather or vinyl
- Polystyrene cores



Product Name	Product Code	Dimensions	Fabric Groups						
			1	2	3	4	5	6	7
 530 Round	VAL/530	H450 W525 D525	£213	£220	£241	£263	£296	£344	£406
 530 Round 1 Bite	VAL/530/1B	H450 W485 D525	£214	£221	£242	£264	£297	£345	£407
 530 Round 2 Bite	VAL/530/2B	H450 W445 D525	£216	£223	£244	£266	£299	£347	£409
 Long	VAL/LONG	H450 W1215 D525	£338	£347	£377	£408	£454	£521	£608
 Long 1 Bite	VAL/LONG/1B	H450 W1140 D525	£337	£346	£376	£406	£452	£520	£607
 Long 2 Bite	VAL/LONG/2B	H450 W1065 D525	£336	£345	£375	£405	£451	£519	£606
 600 Hexagonal	VAL/600/HEX	H450 W593 D515	£220	£227	£250	£273	£308	£360	£426
 Cross Elements	VAL/SQ	H450 W440 D440	£184	£191	£212	£234	£267	£315	£377

If fabrics in two or more different groups are used on one product it will be priced in the highest group. For any patterned or velvet fabrics a 10% surcharge is applied.

Valbo



These Valbo stools all have timber cores.

- Schools, Colleges, Student accommodation
- Reception/ Break-Out
- Libraries

Product Information

- Black feet
- Upholstered in your choice of a wide range of fabric, leather or vinyl
- Wooden cores

Product Name	Product Code	Dimensions	Fabric Groups						
			1	2	3	4	5	6	7
 900 Round	VAL/900	H450 W900 D900	£376	£386	£419	£452	£502	£576	£671
 Large Ying	VAL/LGYING	H450 W1340 D880	£467	£478	£510	£544	£594	£668	£763
 Large Ying with Back	VAL/LGYING/B	H720 W1340 D880 SH450	£663	£680	£731	£783	£861	£977	£1,126
 Angled Stool	VAL/ANG	H450 W640 D590	£264	£271	£292	£314	£346	£395	£457
 Stool	VAL/STOOL	H450 W650 D560	£257	£263	£285	£306	£339	£387	£449
 Cross	VALBO/CROSS	H450 W1370 D1370	£676	£691	£737	£785	£857	£963	£1,100

If fabrics in two or more different groups are used on one product it will be priced in the highest group. For any patterned or velvet fabrics a 10% surcharge is applied.

Education

Rhubarb has fun, colourful ranges for all settings from libraries to classrooms.

Beanbag



Product information

- Removable cover
- Exhaust vent permits rapid air escape
- Polystyrene beans in sealed inner liner
- Upholstered in wide range of fabric, leather or vinyl
- 12-Month manufacturing warranty

Product Name	Product Code	Dimensions
 Beanbag	BEANBAG	DIA650

Product Code	Fabric Groups						
	1	2	3	4	5	6	7
BEANBAG	£155	£163	£187	£212	£249	£304	£375



If fabrics in two or more different groups are used on one product it will be priced in the highest group. For any patterned or velvet fabrics a 10% surcharge is applied.

Dice / Cube



Product information

- Removable covers
- Dice has white vinyl spots, shapes, letters or symbols
- Polystyrene core for minimum weight

Product Name	Product Code	Dimensions
 Dice	DICE	H400 W400
 Cube	CUBE4	H400 W400

Product Code	Fabric Groups						
	1	2	3	4	5	6	7
DICE	£200	£204	£218	£232	£252	£283	£322
CUBE4	£155	£159	£173	£186	£207	£238	£277

If fabrics in two or more different groups are used on one product it will be priced in the highest group. For any patterned or velvet fabrics a 10% surcharge is applied.

Toadstool



Product Information

- Polystyrene core makes it easy to move around with timber base for stability
- White vinyl stalk
- White vinyl spots
- Discounts available when 3 units are ordered in the same fabric

Product Name	Product Code	Dimensions	Fabric Groups						
			1	2	3	4	5	6	7
 Toadstool	TS1A	H410 W430	£212	£216	£229	£243	£264	£295	£334
Toadstool in batches of 3	TS1B		£527	£533	£552	£571	£600	£643	£698

If fabrics in two or more different groups are used on one product it will be priced in the highest group. For any patterned or velvet fabrics a 10% surcharge is applied.









ZigZag

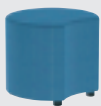

Extensive range of lightweight stools which can be configured to create endless layouts.

Product Information

- Polystyrene core reduces weight of stools
- Timber core in ZigZag Angled Stool and ZigZag Stool
- Upholstered in fabric or vinyl

Product Name	Product Code	Dimensions	Fabric Groups						
			1	2	3	4	5	6	7
 430 Round	ZZ/430	H370 W425 D425	£162	£166	£180	£193	£213	£242	£280
 430 Round 1 Bite	ZZ/430/1B	H370 W380 D425	£161	£165	£178	£191	£211	£241	£279
 430 Round 2 Bite	ZZ/430/2B	H370 W335 D425	£159	£163	£176	£190	£210	£239	£277
 Long	ZZ/LONG	H370 W1025 D425	£248	£253	£270	£287	£313	£352	£401
 Long 1 Bite	ZZ/LONG/1B	H370 W935 D425	£245	£250	£267	£284	£310	£349	£398
 Long 2 Bite	ZZ/LONG/2B	H370 W840 D425	£242	£247	£264	£281	£307	£346	£395
 Angled Stool	ZZ/ANG	H370 W610 D625	£219	£223	£236	£249	£270	£299	£337
 Stool	ZZ/STOOL	H370 W610 D560	£198	£202	£215	£229	£249	£278	£316

If fabrics in two or more different groups are used on one product it will be priced in the highest group. For any patterned or velvet fabrics a 10% surcharge is applied.

Upholstery Services & Bespoke Projects

Rhubarb offers bespoke, made-to-measure upholstery services encompassing a wide range of product including.

- banquette seating
- headboards for hotels and student accommodation
- day beds
- window seats
- bolsters and cushions
- re-upholstery

Let us know what you need and we will do the rest.

Here are a few examples of recent projects.

Upholstery Services & Bespoke Projects



Rhubarb delivers design and build for a wide range of bespoke projects and upholstery / re-upholstery requirements including:

- Banquette seating
- Headboards for hotels and student accommodation
- Day beds
- Window seats
- Bolsters and cushions
- Re-upholstery

Let us know what you need and we will do the rest.

Here are a few examples of recent projects.



Before



After



Office, Task & Desk Chairs

Rhubarb's office seating provides a capsule collection of "good", "better", "best" options, all engineered to provide robustness, durability and real value for money at each price point.

The common denominator is that every one of our chairs is designed with good posture first and foremost – most of us spend too much time sitting at a desk or terminal and providing the best possible support for the back and lumbar, at every price point, is vital.





Century – Good



Good quality entry level task chair with our normal 6-year manufacturing warranty – it doesn't have all the bells and whistles but it's comfortable and it will last.

Product Information

- Height adjustable back with hand wheel locking screw
- Mesh back or fully upholstered
- Black 5-star base with black castors
- Upholstered seat and back rests have deep CMHR foam that can be covered in fabric, vinyl or leather

	Product Name	Product Code	Dimensions	Fabric Groups						
				1	2	3	4	5	6	7
	Medium Back	160	H930-1070 W490 D470 SH460-610	£230	£234	£247	£261	£282	£312	£352
	Medium Back - ordered in batches of 6 in the same fabric			£198	£200	£208	£215	£226	£243	£264
	Medium Back - ordered in batches of 50 in the same fabric			£183	£186	£192	£199	£210	£226	£246
	High Back	162	H1030-1170 W490 D470 SH460-610	£228	£232	£246	£259	£280	£311	£350
	High Back - ordered in batches of 6 in the same fabric			£207	£210	£219	£228	£242	£263	£289
	High Back - ordered in batches of 50 in the same fabric			£189	£191	£200	£208	£221	£241	£265
	Mesh back	160/M	H930-1070 W490 D470 SH460-610	£281	£285	£299	£312	£333	£364	£403
	Mesh back - ordered in batches of 6 in the same fabric			£248	£250	£254	£259	£266	£276	£290
	Mesh back - ordered in batches of 50 in the same fabric			£230	£231	£235	£240	£246	£256	£269
	Cantilever	170	H835 W490 D470 SH450	£232	£237	£250	£264	£285	£315	£354

If fabrics in two or more different groups are used on one product it will be priced in the highest group. For any patterned or velvet fabrics a 10% surcharge is applied.

Optional Features and Prices ● Standard ○ Option x Not applicable

Option	Code	Price	160	160/M	162	170
Pump up lumbar (no ply)	1002	£18	○	x	○	○
12" Draughtsman's kit (as upgrade)	1003/CENT	£50	○	○	○	x
14" Draughtsman's kit (as upgrade)	1004/CENT	£52	○	○	○	x
Height adjustable arms	1006/CENT	£47	○	○	○	x
Ring arms	1009/CENT	£22	○	○	○	○
Independent seat and back mechanism (B3) as upgrade	10032/U	£13	○	○	○	x
Independent seat and back mechanism (B3) with seat slider as upgrade	10061/U	£47	○	○	○	x
Seat Slider	1007	£34	○	○	○	x



Kingston – Better



Mid-range task chair made for comfort and durability

Product Information

- Standard 2-lever mech
- Height adjustable arms
- Upholstered seat and back rests have deep CMHR foam that can be covered in fabric, vinyl or leather
- 3D arm option: height and width adjustable, arm pad with forward and backward movement

	Product Name	Product Code	Dimensions	Fabric Groups						
				1	2	3	4	5	6	7
	Mesh Back	KINGSTON/M	H1010-1180 W670 D670 SH470-550	£517	£521	£535	£549	£569	£600	£639
	High Back	KINGSTON/HB	H960-1140 W670 D670 SH470-550	£525	£530	£546	£563	£588	£624	£671
	Medium Back	KINGSTON/MB	H900-1070 W670 D670 SH470-550	£507	£511	£525	£538	£559	£590	£629

If fabrics in two or more different groups are used on one product it will be priced in the highest group. For any patterned or velvet fabrics a 10% surcharge is applied.

Optional Features and Prices ● Standard ○ Option x Not applicable

Option	Code	Price	KINGSTON/M	KINGSTON/HB	KINGSTON/MB
3D Arm & Pad (PAIR)	10050/U	£16	○	○	○
Independent Seat & Back Mech	10070/U	£28	○	○	○
Pump up lumbar with ply	TEXLUMBER	£25	x	○	○
Seat Slider	10071	£64	○	○	○



Maran – Best



Supremely comfortable task chair with a wide range of standard features.

Product Information

- Body-balance synchro mech
- 2D arms: height adjustable, arm pad with forward and backward movement
- Seat slider
- Adjustable ratchet back
- 3D arm option:
 - Height and width adjustable
 - Arm pad with forward and backward movement

	Product Name	Product Code	Dimensions	Fabric Groups						
				1	2	3	4	5	6	7
	Mesh Back	MARAN/M	H1050-1150 W670 D670 SH490-580	£714	£718	£732	£746	£766	£797	£836
	High Back Upholstered	MARAN/HB	H1030-1200 W670 D670 SH490-580	£672	£678	£697	£716	£745	£788	£843
 rhubarb seating	Medium Back Upholstered	MARAN/MB	H980-1150 W670 D670 SH490-580	£647	£652	£668	£685	£710	£746	£793

If fabrics in two or more different groups are used on one product it will be priced in the highest group. For any patterned or velvet fabrics a 10% surcharge is applied.

Optional Features and Prices ● Standard ○ Option x Not applicable

Option	Code	Price	MARAN/M	MARAN/HB	MARAN/MB	MARAN/C	MARAN/UC
3D Arm & Pad (PAIR)	10051/U	£28	○	○	○	x	x



Royce

A more traditional task chair offering the full range of features and weight-rated to 23 stone.

Product Information

- Shown with optional headrest
- Easy lift back, ratchet height adjustable
- Body-balance synchro mech
- Height adjustable arms
- Seat slider
- Upholstered seat and back rests have deep CMHR foam that can be covered in fabric, vinyl or leather
- Black 5-star base with black castors
- Chrome base available as upgrade
- Suitable for use up to 23 stone



Product Name	Product Code	Dimensions	Fabric Groups						
			1	2	3	4	5	6	7
 Medium Back	ROYCE/MB	H1090-1170 W580 D550 SH450-530 F700	£639	£645	£667	£689	£722	£771	£834
Medium Back (batches of 2 in the same fabric)			£616	£621	£638	£654	£679	£716	£763
 High Back shown with optional headrest	ROYCE/HB	H1160-1240 W580 D550 SH450-530 F700	£658	£665	£688	£712	£747	£799	£866
High Back (batches of 2 in the same fabric)			£636	£641	£659	£677	£704	£744	£795
Headrest	1001		£72	£74	£81	£87	£97	£111	£130

If fabrics in two or more different groups are used on one product it will be priced in the highest group. For any patterned or velvet fabrics a 10% surcharge is applied.

Optional Features and Prices ● Standard ○ Option x Not applicable

Option	Code	Price	ROYCE/MB	ROYCE/HB
Headrest	1001	See above	○	○
Chrome 5-star base (as upgrade)	/CHR	£45	○	○
Memory foam	10037	£25	○	○
Pump up lumber (with ply)	TEXLUMBER	£25	○	○

Bariatric Chairs

Rhubarb manufactures some of the best bariatric seating available, enabling all organisations to fulfil their obligation to provide equipment for their employees that is fit for purpose and allows them to undertake their work safely.



Both the swivel and 4-leg bariatric chair are certified to accommodate weights up to 50 stone.

Excelsior



Product Information

- Upholstered seat and back rests have deep CMHR foam that can be covered in fabric, leather or vinyl
- Tested for use up to 50 stone
- BS EN15373:2017 – Strength, durability and safety requirements for non-domestic seating
- 2 year manufacturing warranty

Product Name	Product Code	Dimensions	Fabric Groups						
			1	2	3	4	5	6	7
 High Back Swivel	660XL	H1080-1190 W590 D510 SH425-535 F700	£1,155	£1,165	£1,196	£1,227	£1,275	£1,345	£1,436
 High Back Swivel with no arms	660XL/NA	H1080-1190 W590 D510 SH425-535 F700	£1,037	£1,047	£1,078	£1,109	£1,157	£1,227	£1,318

If fabrics in two or more different groups are used on one product it will be priced in the highest group. For any patterned or velvet fabrics a 10% surcharge is applied.

Optional Features and Prices Standard Option Not applicable

Option	Code	Price	660XL	660XL/NA
Memory foam	10037	£25	<input type="radio"/>	<input type="radio"/>
Pump up lumber (with ply)	TEXLUMBER	£25	<input type="radio"/>	<input type="radio"/>

Excelsior Wood



Product Information

- Upholstered extra-wide seat and back rests have deep CMHR foam that can be covered in fabric, leather or vinyl
- Beech coloured wood frame
- Tested for use up to 50 stone
- 2 year manufacturing warranty

Product Name	Product Code	Dimensions	Fabric Groups						
			1	2	3	4	5	6	7
 Excelsior Wood	671	H890 W830 D560 SH490	£818	£831	£869	£909	£969	£1,057	£1,170

If fabrics in two or more different groups are used on one product it will be priced in the highest group. For any patterned or velvet fabrics a 10% surcharge is applied.

Optional Features and Prices Standard Option Not applicable

Option	Code	Price	671
Memory foam	10037	£25	<input type="radio"/>

24 Hour Chairs

For those who work in call centres and other 24/7 environments, specialised seating is required.

Rhubarb's range of 24/7 chairs has been tested for 24-hour use and is specifically designed to deliver the comfort and support needed to meet those demands.

For 24-hour use, we ONLY recommend 24-hour rated fabrics. Chairs supplied in alternative fabric will not be covered by our warranty.

Our specialist seating ranges have a 2-year warranty against manufacturing defects.

Eon



Product Information

- Easy lift back, ratchet height adjustable
- Independent seat and back mechanism with tension control
- Upholstered seat and back rests have deep CMHR foam that can be covered in fabric, leather or vinyl
- Black 5-star base with black castors
- S1 Level Tested (severe test) for 24 hour use.
- Two year manufacturing warranty for 24 hour use (when upholstered with 24/7 fabric)
- Suitable for use up to 23 stone

Product Name	Product Code	Dimensions	24/7 Fabric
 Eon Medium Back shown with optional arms	260	H835-925 W550 D520 SH470-600 F670	£348
 Eon High Back	262	H925-1030 W550 D520 SH470-600 F670	£363

If fabrics in two or more different groups are used on one product it will be priced in the highest group. For any patterned or velvet fabrics a 10% surcharge is applied.

Optional Features and Prices ● Standard ○ Option x Not applicable





Option	Code	Price	260	262
12" Draughtsman's kit as upgrade	1003/EON	£47	○	○
14" Draughtsman's kit as upgrade	1004/EON	£49	○	○
Height adjustable arms	1006/EON	£47	○	○
Ring arms	1009/EON	£22	○	○
Fold back arms	10011/EON	£50	○	○

Zenith



Product Information

- Easy lift back, ratchet height adjustable
- Independent seat and back mechanism with tension control
- Height adjustable arms
- Seat slider
- Upholstered seat and back rests have deep molded CMHR foam that can be covered in fabric, leather or vinyl
- Black 5-star base with black castors
- S1 Level Tested (severe test) for 24 hour use.
- Two year manufacturing warranty for 24 hour use (when upholstered with 24/7 fabric)
- Suitable for use up to 23 stone
- Shown with optional headrest

	Product Name	Product Code	Dimensions	24/7 Fabric
	Zenith High Back (Dimensions without optional headrest)	9003	H1160-1240 W580 D550 SH450-530 F700	£1,000
	Zenith High Back (Batches of 2 in the same fabric)			£945
	Zenith Medium Back	9002	H1090-1170 W580 D550 SH450-530 F700	£971
	Zenith Medium Back (Batches of 2 in the same fabric)			£924
	Zenith Mesh Back	9003/M	H1050-1220 W580 D550 SH450-530 F700	£1,055
	Zenith Mesh Back with Headrest	9003/M/HEAD	H1230-1400 W580 D550 SH450-530 F700	£1,170

If fabrics in two or more different groups are used on one product it will be priced in the highest group. For any patterned or velvet fabrics a 10% surcharge is applied.

Optional Features and Prices ● Standard ○ Option x Not applicable

Option	Code	Price	9003	9002	9003/M
Headrest	1001	£97	○	○	x
Chrome 5-star base (as upgrade)	/CHR	£45	○	○	○
Memory foam	10037	£25	○	○	○
Pump up lumber (with ply)	TEXLUMBER	£25	○	○	x

Multipurpose Seating

Our extensive range of multipurpose chairs and stools delivers both style and functionality in a wide variety of settings from office to café, education to healthcare.

Mata – 4 Leg

Mata has stood the test of time and continues to be a hugely successful product. It combines attractive design, robust construction, flexible shell, range of frames and colours to make it an obvious choice from classroom to cafeteria, office to waiting room, student accommodation to healthcare.

Details of the Mata family are provided on this and the following pages.

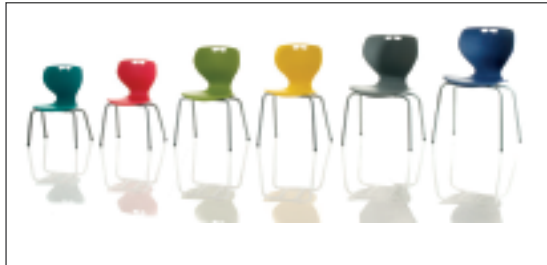







Product information for all frames:

- Moulded polypropylene shell
- 7 standard colours: Black, White, Grey, Blue, Red, Olive, Mango
- Other shell colours available subject to minimum order quantity of 300
- Chair sizes 1-5 available on special order, subject to minimum order quantity of 100
- Upholstered seat pad available on size 5 and 6 chairs
- BS EN1729 Parts 1 & 2 (functional dimensions and safety requirements)
- BS 4875: Part 1: 2001 Test Level 4 (strength and durability)
- BS 7945: 1999 (stability)
- Weight tested to 19 stone
- For feature video see www.rhubarbseating.co.uk/mata

Product Information for Mata 4-leg:

- Stacks up to 5 high
- Fully welded silver EPC frame
- Chair sizes 2 to 4 available on special order, subject to minimum order quantity of 100

Product Name	Product Code	Dimensions	Price
 4 Leg Chair	SM1L	H525 W300 D290 SH260	£79
 4 Leg Chair	SM2L	H570 W300 D290 SH310	£76
 4 Leg Chair	SM3L	H680 W360 D350 SH350	£79
 4 Leg Chair	SM4L	H700 W360 D350 SH380	£76
 4 Leg Chair	SM5L	H775 W430 D490 SH430	£77
 4 Leg Chair	SM6L	H805 W430 D490 SH460	£77
4 Leg Chair (order quantity of minimum 100 units - one drop)			£74

Optional Features and Prices ● Standard ○ Option x Not applicable

Option	Code	Price	SM1L	SM2L	SM3L	SM4L	SM5L	SM6L
Seat pad	MATAUPHPAD	See Below	x	x	x	x	○	○

Product Name	Product Code	Fabric Groups						
		1	2	3	4	5	6	7
Seat pad – individual	MATAUPHPAD	£58	£63	£76	£90	£111	£141	£180
Seat pad – batch of 2	MATAUPHPAD/2	£46	£48	£55	£62	£72	£87	£107
Seat pad – batch of 5	MATAUPHPAD/5	£41	£42	£46	£51	£57	£66	£78
Seat pad – batch of 100+	MATAUPHPAD/100	£34	£35	£38	£41	£46	£53	£62



If fabrics in two or more different groups are used on one product it will be priced in the highest group. For any patterned or velvet fabrics a 10% surcharge is applied.

Mata – Cantilever



Product information

- Stacks up to 5 high
- Fully welded silver EPC frame
- Chair sizes 2 to 4 available on special order, subject to minimum order quantity of 100

Product Name	Product Code	Dimensions	Price
 Reverse Cantilever Chair	SM2C	H565 W300 D290 SH310	£82
 Reverse Cantilever Chair	SM4C	H660 W360 D410 SH380	£82
 Reverse Cantilever Chair	SM6C	H810 W430 D520 SH460	£82
Reverse Cantilever Chair (order quantity of more than 100 units - one drop)			£77

Optional Features and Prices ● Standard ○ Option x Not applicable

Option	Code	Price	SM2C	SM4C	SM6C
Seat pad	MATAUPHPAD	See Below	x	x	○

Product Name	Product Code	Fabric Groups						
		1	2	3	4	5	6	7
Seat pad – individual	MATAUPHPAD	£58	£63	£76	£90	£111	£141	£180
Seat pad – batch of 2	MATAUPHPAD/2	£46	£48	£55	£62	£72	£87	£107
Seat pad – batch of 5	MATAUPHPAD/5	£41	£42	£46	£51	£57	£66	£78
Seat pad – batch of 100+	MATAUPHPAD/100	£34	£35	£38	£41	£46	£53	£62





If fabrics in two or more different groups are used on one product it will be priced in the highest group. For any patterned or velvet fabrics a 10% surcharge is applied.

Mata – Swivel & Sled



Product information

- Swivel chair has black polypropylene 5-star base on castors (standard) or glides
- Optional draughtsman's kits available for swivel chair
- Sled chair stacks up to 5 high
- Sled chair is available with chrome frame or with powder-coated silver frame

Product Name	Product Code	Dimensions	Price
 Mata swivel	SM6S	H795-925 W610 D610 SH410-550	£126
 Sled Base Chair Chrome base	SL6/CHR	H805 W500 D600 SH460	£120
 Sled Base Chair Black base	SL6/B	H805 W500 D600 SH460	£85
 Sled Base Chair Silver base	SL6/S	H805 W500 D600 SH460	£85

Optional Features and Prices ● Standard ○ Option x Not applicable

Option	Code	Price	SM6S	SL6/CHR	SL6/B	SL6/S
12" Draughtsman's kit	1003/SM6S	£50	○	x	x	x
14" Draughtsman's kit	1004/SM6S	£52	○	x	x	x
Seat pad	MATAUPHPAD	See below	○	○	○	○

Product Name	Product Code	Fabric Groups						
		1	2	3	4	5	6	7
Seat pad – individual	MATAUPHPAD	£58	£63	£76	£90	£111	£141	£180
Seat pad – batch of 2	MATAUPHPAD/2	£46	£48	£55	£62	£72	£87	£107
Seat pad – batch of 5	MATAUPHPAD/5	£41	£42	£46	£51	£57	£66	£78
Seat pad – batch of 100+	MATAUPHPAD/100	£34	£35	£38	£41	£46	£53	£62



If fabrics in two or more different groups are used on one product it will be priced in the highest group. For any patterned or velvet fabrics a 10% surcharge is applied.

Mata – High Stool



Product information

- Available with either sled or 4-leg frame
- Chrome or silver powder-coated frame option for 4-leg high stool

Product Name	Product Code	Dimensions	Price
 Mata High Sled 620mm high	MATA/ SLSTOOL/S/62	H1020 W580 D580 SH640	£121
 Mata 4 Leg Stool - Chrome	MATA/STOOL/CH	H1110 W510 D500 SH730	£167
 Mata 4 Leg Stool - Silver	MATA/STOOL/S	H1110 W510 D500 SH730	£112

Optional Features and Prices ● Standard ○ Option x Not applicable

Option	Code	Price	MATA/SLSTOOL/S/62	MATA/STOOL/CH	MATA/STOOL/S
Seat pad	MATAUPHPAD	See below	○	○	○

Product Name	Product Code	Fabric Groups						
		1	2	3	4	5	6	7
Seat pad – individual	MATAUPHPAD	£58	£63	£76	£90	£111	£141	£180
Seat pad – batch of 2	MATAUPHPAD/2	£46	£48	£55	£62	£72	£87	£107
Seat pad – batch of 5	MATAUPHPAD/5	£41	£42	£46	£51	£57	£66	£78
Seat pad – batch of 100+	MATAUPHPAD/100	£34	£35	£38	£41	£46	£53	£62

If fabrics in two or more different groups are used on one product it will be priced in the highest group. For any patterned or velvet fabrics a 10% surcharge is applied.



Prima



Prima is suitable for use in almost every environment, combining style with exceptional durability and a wide range of options.

Product information

- Self-linking system with additional link extensions available (n/a Cantilever)
- Black moulded polypropylene shell. Other colours available subject to minimum order quantities, please enquire
- Upholstered seat and back rests have deep CMHR foam that can be covered in fabric, leather or vinyl
- Available with laptop tablet (see options below)
- Stacks up to 10 high
- BS 4875: Part 1: 2001 Test Level 4 (strength and durability)
- BS 7945: 1999 (stability)
- BS EN 16139:2013 – Test Level 2 – “Furniture – Strength, durability and safety – Requirements for non-domestic seating”
- Suitable for use up to 32 stone
- Prima also available in fixed or tip-up beam configuration
- 10 year manufacturing warranty

Product Name	Product Code	Dimensions	Price	Fabric Groups						
				1	2	3	4	5	6	7
 4 Leg Chair Black Frame - Fully Upholstered (shown with optional laptop tablet)	PRIMA/BF/UPH	H800 W520 D580 SH485	–	£231	£235	£248	£262	£283	£313	£353
 4 Leg Chair Black Frame - Polyprop seat and back (shown with optional arms)	PRIMA/BF/PP	H800 W520 D580 SH485	£130	–	–	–	–	–	–	–
 4 Leg Chair Black Frame - Upholstered seat and polyprop back	PRIMA/BF/UPH/PP	H800 W520 D580 SH485	–	£199	£204	£217	£231	£252	£282	£321

If fabrics in two or more different groups are used on one product it will be priced in the highest group. For any patterned or velvet fabrics a 10% surcharge is applied.

Optional Features and Prices ● Standard ○ Option x Not applicable

Option	Code	Price	PRIMA/BF/UPH	PRIMA/BF/PP	PRIMA/BF/UPH/PP
Fixed arms (Black) - pair	10053	£67	○	○	○
Right laptop tablet including arm (stacks up to 4 high)	10054	£73	○	○	○
Left laptop tablet including arm (stacks up to 4 high)	10055	£73	○	○	○
Right anti-panic tablet including arm (non-stacking)	10056	£75	○	○	○
Left anti-panic tablet including arm (non-stacking)	10057	£75	○	○	○
Extension link connector	10059	£5	○	○	○

Prima Nest & Stack





This unique tablet chair stacks **with the tablet** to at least 8 high and also nests for storage with the seat tipped up to avoid the risks associated with lifting the chair to stack.

Product information

- Silver EPC frame
- Black moulded polypropylene shell, back only
- Optional upholstered seat and back pads that can be covered in fabric, leather or vinyl
- Available either with castors at the front and glides at the back for the best combination of ease of movement and seated safety, or with castors.
- Tablet option right hand only
- Discount is negotiable on order quantities of more than 200 units

NB: dimensions given for width (W) and depth (D) include tablet

Product Name	Product Code	Dimensions	Price	Fabric Groups						
				1	2	3	4	5	6	7
 Prima nest and stack - Fully Upholstered, castors & glides	PRIMANEST/UPH/CG	H810 W530 D780 SD460 SH440	-	£273	£277	£291	£304	£325	£356	£395
 Prima nest and stack - Upholstered Seat & PP Back, castors & glides	PRIMANEST/UPH/PP/CG	H810 W530 D780 SD460 SH440	-	£282	£286	£300	£313	£334	£365	£404

If fabrics in two or more different groups are used on one product it will be priced in the highest group. For any patterned or velvet fabrics a 10% surcharge is applied.

Optional Features and Prices ● Standard ○ Option x Not applicable

Option	Code	Price	PRIMANEST/UPH/CG	PRIMANEST/UPH/PP/CG
T-Shaped Arm Rest (PAIR)	10058	£78	○	○
T-Shaped Arm Rest & Tablet	10052	£103	○	○



Renza









Renza has flair and functionality, making it an ideal solution for the meeting room and front office.

A wide range of components provides different back versions, which can be combined with a large number of frames for a complete, unrivalled collection.

Product information

- Chrome frame
- Black 5-star pyramid base as swivel
- Black mesh
- Upholstered in a wide variety of fabric, leather and vinyl



	Product Name	Product Code	Dimensions	Price	Fabric Groups						
					1	2	3	4	5	6	7
	4-Leg Mesh Back - Chrome Frame	RENZA/4LEG /MESH	H830 W560 D550 SH470	-	£243	£245	£252	£259	£270	£286	£306
	4-Leg Medium Back Upholstered	RENZA/4LEG /MB	H830 W560 D550 SH470	-	£254	£257	£268	£279	£296	£321	£352
	4-Leg High Back Upholstered	RENZA/4LEG /HB	H920 W560 D550 SH470	-	£269	£272	£281	£290	£305	£326	£353
	Cantilever Mesh Back	RENZA/CANT /MESH	H845 W660 D560 SH450	-	£253	£256	£263	£270	£281	£296	£317
	Cantilever Medium Back Upholstered	RENZA/CANT /MB	H845 W660 D560 SH450	-	£265	£268	£279	£290	£307	£332	£363
	Cantilever High Back Upholstered	RENZA/CANT /HB	H940 W660 D560 SH450	-	£279	£282	£292	£301	£316	£337	£364
	Swivel Mesh Back	RENZA/SWI /MESH	H885-975 W 790 D 490 SH 465-555	-	£266	£268	£275	£282	£293	£309	£329
	Swivel Medium Back Upholstered	RENZA/SWI /MB	H885-975 W 790 D 490 SH 465-555	-	£302	£306	£317	£328	£344	£369	£401
	Swivel High Back Upholstered	RENZA/SWI /HB	H985-1075 W 790 D 490 SH 465-555	-	£317	£320	£329	£339	£353	£374	£402

If fabrics in two or more different groups are used on one product it will be priced in the highest group. For any patterned or velvet fabrics a 10% surcharge is applied.

5-Wave









Superbly designed and engineered chair which features powder-coated frame to match the shell.

Product built to order only. Minimum order quantities apply.

Product Information

- Moulded polypropylene shell with powder coated frame to match
- 5 standard colours: Black, Light Green, Grey, Red, White
- Custom shell colours available
- 4-leg and sled base chairs are stackable
- ANSI/BIFMA x5.1-2011: General Purpose Office Chairs tested for strength, stability and durability
- Innovative '5-Wave' design representing Rigid Structure, Contoured Shape, Ergonomic Design, Robust Shell & Flex Movement to support posture

	Product Name	Product Code	Dimensions	Price
	5 Wave 4 Leg Chair	5WAVE/4LEG	H795 W415 D505 SH430	£161
	5 Wave 4 Leg Chair with Arms	5WAVE/4LEG/A	H795 W540 D505 SH430	£189
	5 Wave Sled Base Chair	5WAVE/SLED	H795 W415 D505 SH430	£171
	5 Wave Sled Base Chair with Arms	5WAVE/SLED/A	H795 W540 D505 SH430	£199
	5 Wave Swivel Chair	5WAVE/TYP	H745-850 W415 D505 SH380-485 F600	£194
	5 Wave High Stool	5WAVE/STOOL	H1105 W415 D505 SH740	£202

FourStar



This polyprop chair is an ideal choice for education use at all levels. Upholstered seat pad available.

Product Information

- 5 standard colours
- Large writing tablet mounted on gas column caters for left and right-handed users
- 5-star black base on black castors

Standard colours:

- Grey
- Yellow
- Blue
- Fuchsia
- Green

Product Name	Product Code	Dimensions
--------------	--------------	------------



Four Star Tablet Swivel	FOUR/TAB	H820 W445 D530 SH450
-------------------------	----------	-------------------------

Four Star seat pad	FOUR/SP	-
--------------------	---------	---

Product Code	Price	Fabric Groups						
		1	2	3	4	5	6	7
FOUR/TAB	£264	-	-	-	-	-	-	-
FOUR/SP	-	£55	£58	£67	£77	£92	£113	£140

If fabrics in two or more different groups are used on one product it will be priced in the highest group. For any patterned or velvet fabrics a 10% surcharge is applied.

Trike



A perfect option for student and training environments with an extra-large tablet and bag storage tray.

Product Information

- Injection moulded polypropylene frame in white or grey
- Polypropylene seat in 4 standard colours
- Large tablet suitable for laptop
- Upholstered seat pad available
- Anti-Panic mechanism on writing tablet tested to 50kg loads (right-hand available only)
- Tripod base 600mm diameter in grey

Product Name	Product Code	Dimensions
--------------	--------------	------------



Trike with tablet	TRIKE2/T	H890 W580 D600 SH450
-------------------	----------	-------------------------

Trike upholstered seat pad	TRIKE2/T/PAD	-
----------------------------	--------------	---

Product Code	Price	Fabric Groups						
		1	2	3	4	5	6	7
TRIKE2/T	£389	-	-	-	-	-	-	-
TRIKE2/T/PAD	-	£64	£67	£76	£85	£98	£118	£144

If fabrics in two or more different groups are used on one product it will be priced in the highest group. For any patterned or velvet fabrics a 10% surcharge is applied.

Primero

Classic chrome wire-frame polyprop chair for use in multiple environments .

Product information

- Moulded polypropylene seat and back
- 5 standard colours: Black, Light Grey, Light Blue, Pumpkin, Burgundy
- 11mm steel rod frame
- Upholstered seat and back pads available as options
- Stackable up to 16 high



Product Name	Product Code	Dimensions	Price	Fabric Groups						
				1	2	3	4	5	6	7
 Sled Chrome Base	PRIM1	H800 W525 D540 SH460	£119	-	-	-	-	-	-	-
Seat pad	PRIMSP		-	£55	£58	£66	£74	£87	£105	£128

If fabrics in two or more different groups are used on one product it will be priced in the highest group. For any patterned or velvet fabrics a 10% surcharge is applied.

Optional Features and Prices ● Standard ○ Option ✕ Not applicable

Option	Code	Price	PRIM1
Primero P shaped tablet - chrome arm, black tablet, RH	PRIM2	£93	○
Primero P shaped tablet - chrome arm, black tablet, LH	PRIM3	£93	○

Industrial Seating

Rhubarb has a large range of industrial seating that is best in class.

Combining the comfort and ergonomic needs of the individual with the dynamic needs of industrial or technical environments requires a specialist approach – we have the range of seating designed and constructed to meet all these needs.

Foot-operated gas-lift is available for all our industrial seating ranges – please enquire.

Suitability Key

To help with specifying the most suitable seating for your requirements, the symbols below are shown alongside the seating appropriate for the areas indicated.



▲ Laboratory



▲ Sterile
Hygiene



▲ Industrial
Technical



▲ ESD
Static Safe



▲ HEPA
Filter



▲ Medical
Grade

Saddle & Perch



Product information





- Soft touch polyurethane seat on PU Saddle
- Black 5-star base on Saddle and Perch
- Castors as standard on Saddle and Perch.
- Glides available as option



▲ Laboratory



▲ Industrial Technical

Product Name	Product Code	Dimensions	Price	Fabric Groups						
				1	2	3	4	5	6	7
 Saddle upholstered	202/B/P	H555-730 W640 D590 SH555-730	-	£191	£195	£209	£224	£246	£278	£319
 Saddle upholstered with aluminium base	202/CH	H555-730 W640 D590 SH555-730	-	£228	£233	£247	£261	£282	£314	£355
 PU Saddle	201/B/P	H600-780 W640 D590 SH600-780 F610	£185	-	-	-	-	-	-	-
 PU Perch	205	H650-840 W333 D350 SH530-715 F610	£153	-	-	-	-	-	-	-

If fabrics in two or more different groups are used on one product it will be priced in the highest group. For any patterned or velvet fabrics a 10% surcharge is applied.

Optional Features and Prices ● Standard ○ Option x Not applicable

Option	Code	Price	202/B/P	202/CH	201/B/P	205
25" Chrome base for Saddle only (as upgrade)	10013/U	£41	○	●	○	○
Black steel 5-star base for Saddle only	10014/U	£13	○	○	x	x
Tilt mechanism for Saddle (as upgrade)	10017	£38	○	○	○	x

TechChair & TechStools



Product information





- Upholstered seat and back in fabric as standard
- Black polypropylene 5-star base
- Glides as standard on high and medium chairs and stools, castors as standard on low chairs and stools



▲ Laboratory



▲ Industrial Technical

	Product Name	Product Code	Dimensions	Fabric Groups						
				1	2	3	4	5	6	7
	TechChair High	TC101B/O	H960-1310 W500 D470 SH570-820 F710	£353	£358	£375	£392	£418	£456	£505
	TechChair High – Ordered in multiples of 2			£330	£335	£349	£363	£385	£417	£458
	TechChair Medium	TC102B/O	H930-1190 W500 D470 SH520-710 F710	£351	£356	£373	£390	£416	£454	£503
	TechChair Medium – Ordered in multiples of 2			£328	£333	£347	£361	£383	£415	£456
	TechChair Low	TC103B/O	H870-1070 W500 D470 SH440-580 F670	£295	£301	£318	£335	£360	£398	£447
	TechChair Low – Ordered in multiples of 2			£274	£279	£293	£307	£329	£361	£403
	TechStool High	TC108	H650-810 W420 D420 SH650-810 F710	£239	£243	£257	£271	£293	£325	£365
	TechStool High – Ordered in multiples of 3			£208	£210	£214	£219	£226	£237	£251
	TechStool Medium	TC109	H570-690 W420 D420 SH570-690 F710	£237	£241	£255	£270	£291	£323	£363
	TechStool Medium – Ordered in multiples of 3			£206	£208	£212	£217	£225	£235	£249
	TechStool Low	TC110	H440-570 W420 D420 SH440-570 F670	£185	£189	£203	£218	£239	£271	£311
	TechStool Low – Ordered in multiples of 3			£156	£157	£162	£167	£174	£185	£199

If fabrics in two or more different groups are used on one product it will be priced in the highest group. For any patterned or velvet fabrics a 10% surcharge is applied.

Optional Features and Prices ● Standard ○ Option x Not applicable

Option	Code	Price	TC101B	TC102B	TC103B	TC108	TC109	TC110
Independent seat and back mechanism S3 (as upgrade)	10032/U	£13	○	○	○	x	x	x
Brake unloaded soft tyre castors (as upgrade)	10024/U	£17	x	x	○	x	x	○
Brake unloaded hardwheel castors	10025/U	£5	○	○	○	○	○	○
Brake loaded soft tyre castors (as upgrade)	10023/U	£30	○	○	○	○	○	○
Standard castors	10034	£7	x	x	●	x	x	●
Glides	10035	£6	●	●	○	●	●	○
Height adjustable arms	1006/TECH	£47	○	○	○	x	x	x

PU TechChair & TechStools



This PU range is our own design with a larger seat and back than other PU chairs available on the market making them more comfortable and more suitable for prolonged use.

Product information







- Soft touch polyurethane seat and back
- Black polypropylene 5-star base
- BS 5459: Part 2: 2000
- Glides as standard on high and medium chairs and stools, castors as standard on low chairs and stools



▲ Laboratory



▲ Industrial Technical

Product Name	Product Code	Dimensions	Price
 PU Chair High	TCPU4	H910-1270 W470 D450 SH580-840 F710	£395
 PU Chair Medium	TCPU5	H830-1120 W470 D450 SH510-700 F710	£393
 PU Chair Low	TCPU6	H750-980 W470 D450 SH430-570 F670	£340
 PU Stool High	PU151	H530-780 W350 D350 SH530-780 F710	£174
 PU Stool Medium	PU152	H470-660 W350 D350 SH470-660 F710	£172
 PU Stool Low	PU153	H410-540 W350 D350 SH410-540 F670	£123

Optional Features and Prices ● Standard ○ Option x Not applicable

Option	Code	Price	PU4	PU5	PU6	PU151	PU152	PU153
Independent seat and back mechanism (B3) (as upgrade)	10032/U	£13	○	○	○	x	x	x
Independent seat and back mechanism (B3) with seat slider (as upgrade)	10061/U	£47	○	○	○	x	x	x
Brake unloaded soft tyre castors(as upgrade)	10024/U	£17	x	x	○	x	x	○
Brake loaded soft tyre castors (as upgrade)	10023/U	£30	○	○	○	○	○	○
Standard castors	10034	£7	x	x	●	x	x	●
Glides	10035	£6	●	●	○	●	●	○

Static Safe TechChair & TechStools



Product information

- Camira Hi-Tech ESD fabric
- ESD freewheeling castors/ ESD glides
- Aluminium 5-star base and column
- Glides as standard on high and medium chairs and stools, castors as standard on low chairs and stools









▲ Laboratory



▲ ESD
Static Safe



▲ Industrial
Technical

	Product Name	Product Code	Dimensions	Price
	ESD Chair High	TC201B/O	H950-1290 W500 D470 SH560-810 F710	£475
	ESD Chair High – Ordered in multiples of 2			£447
	ESD Chair Medium	TC202B/O	H920-1180 W500 D470 SH510-700 F710	£474
	ESD Chair Medium – Ordered in multiples of 2			£446
	ESD Chair Low	TC203B/O	H860-1060 W500 D470 SH430-570 F670	£474
	ESD Chair Low – Ordered in multiples of 2			£446
	ESD Stool High	TC208	H510-760 W420 D420 SH530-780 F710	£288
	ESD Stool High – Ordered in multiples of 6			£242
	ESD Stool Medium	TC209	H460-650 W420 D420 SH480-670 F710	£290
	ESD Stool Medium – Ordered in multiples of 6			£244
	ESD Stool Low	TC210	H356-526 W420 D420 SH376-546 F670	£298
	ESD Stool Low – Ordered in multiples of 6			£252

Optional Features and Prices ● Standard ○ Option x Not applicable

Option	Code	Price	TC201	TC202	TC203	TC208	TC209	TC210
Independent seat and back mechanism S3 (as upgrade)	10032/U	£13	○	○	○	x	x	x
Brake unloaded soft tyre ESD castors - set of 5 (Upgrade from Castors) (as upgrade)	10022/U	£1	x	x	○	x	x	○
Brake loaded soft tyre ESD castors (Upgrade from Glides)	10021/U	£47	x	○	x	○	○	○
Brake loaded soft tyre ESD castors (Upgrade from Castors)	10021/U	£11	x	x	○	x	x	○
ESD glides	10036	£11	●	●	○	●	●	○
ESD freewheeling castors	10080	£47	x	x	●	x	x	●

Static Safe & Sterile TechChair & Tech Stools



Product information

- Black ESD vinyl only
- ESD freewheeling castors/ ESD glides
- HEPA filter on chairs
- Aluminium 5-star base and column
- Glides as standard on high and medium chairs and stools, castors as standard on low chairs and stools



▲ Laboratory









▲ ESD Static Safe



▲ Sterile Hygiene



▲ HEPA Filter

Product Name	Product Code	Dimensions	Price
 ESD & Sterile Chair High	TC304B/O	H950-1290 W500 D470 SH560-810 F710	£442
ESD & Sterile Chair High – Ordered in multiples of 2			£422
 ESD & Sterile Chair Medium	TC305B/O	H920-1180 W500 D470 SH510-700 F710	£444
ESD & Sterile Chair Medium – Ordered in multiples of 2			£424
 ESD & Sterile Chair Low	TC306B/O	H860-1060 W500 D470 SH430-570 F670	£443
ESD & Sterile Chair Low – Ordered in multiples of 2			£423
 ESD & Sterile Stool High	TC308	H510-760 W420 D420 SH530-780 F710	£263
ESD & Sterile Stool High – Ordered in multiples of 6			£241
 ESD & Sterile Stool Medium	TC309	H460-650 W420 D420 SH480-670 F710	£266
ESD & Sterile Stool Medium – Ordered in multiples of 6			£244
 ESD & Sterile Stool Low	TC310	H356-526 W420 D420 SH376-546 F670	£260
ESD & Sterile Stool Low – Ordered in multiples of 6			£238

Optional Features and Prices ● Standard ○ Option x Not applicable

Option	Code	Price	TC304	TC305	TC306	TC308	TC309	TC310
Independent seat and back mechanism S3 (as upgrade)	10032/U	£13	○	○	○	x	x	x
Brake unloaded soft tyre ESD castors - set of 5 (Upgrade from Glides) (as upgrade)	10022/U	£35	x	x	○	x	x	○
Brake loaded soft tyre ESD castors (Upgrade from Glides) (as upgrade)	10021/U	£47	○	○	x	○	○	x
Brake loaded soft tyre ESD castors (Upgrade from Castors)	10021/U	£11	x	x	○	x	x	○
ESD glides	10036	£11	●	●	○	●	●	○
ESD freewheeling castors	10080	£47	x	x	●	x	x	●

Medical Grade Clean Room TechChairs



Product information

- Medical grade vinyl upholstery only
- HEPA filter
- Aluminium 5-star base and column
- Glides as standard on high and medium chairs and stools, castors as standard on low chairs and stools



▲ Laboratory





▲ Industrial Technical



▲ HEPA Filter



▲ Medical Grade

Product Name	Product Code	Dimensions	Fabric Groups						
			1	2	3	4	5	6	7
 Medical Grade Chair High	TC311B/O	H950-1290 W500 D470 SH560-810 F710	-	£433	£450	£467	£493	£531	£579
Medical Grade Chair High – Ordered in multiples of 2			-	£413	£427	£441	£463	£495	£536
 Medical Grade Chair Medium	TC312/O	H920-1180 W500 D470 SH510-700 F710	-	£435	£452	£469	£495	£533	£582
Medical Grade Chair Medium – Ordered in multiples of 2			-	£415	£429	£443	£465	£497	£539
 Medical Grade Chair Low	TC313B/O	H860-1060 W500 D470 SH430-570 F670	-	£381	£398	£415	£441	£479	£527
Medical Grade Chair Low – Ordered in multiples of 2			-	£363	£377	£391	£413	£445	£486

If fabrics in two or more different groups are used on one product it will be priced in the highest group. For any patterned or velvet fabrics a 10% surcharge is applied.

Optional Features and Prices ● Standard ○ Option x Not applicable

Option	Code	Price	TC311B	TC312B	TC313B
Independent seat and back mechanism S3 (as upgrade)	10032/U	£13	○	○	○
Brake unloaded soft tyre castors (as upgrade)	10024/U	£17	x	x	○
Brake unloaded hardwheel castors	10025/U	£5	○	○	○
Brake loaded soft tyre castors (as upgrade)	10023/U	£30	○	○	○
Glides	10035	£6	●	●	○
Standard castors	10034	£7	x	x	●

Beam Seating

For public spaces and waiting areas, beam seating is often the best solution and Rhubarb has one of the widest ranges available in the market. Some of our most popular multipurpose chairs can be beam configured and we also have a strong offering of specific beam seating. All in all, this range combines quality with cost-effectiveness and is designed throughout to meet the practical needs of public spaces from cleaning and maintenance to security and durability.

Mata Beam







Product information

- Black fixed seat beam frame
- Moulded polypropylene shell
- Upholstered seat pad available
- 7 standard colours: Black, White, Grey, Blue, Red, Olive, Mango
- Other shell colours available subject to minimum order quantities
- Round cornered square table option available in place of one or more beam seats.



▲ Round Cornered Table

Product Name	Product Code	Dimensions	Price
 Fixed Seat Beam - 2 Seat	MATABEAM2	H830 W950 D510 SH450	£316
 Fixed Seat Beam - 3 Seat	MATABEAM3	H830 W1400 D510 SH450	£497
 Fixed Seat Beam - 4 Seat	MATABEAM4	H830 W1900 D510 SH450	£607
 Fixed Seat Beam - 5 Seat	MATABEAM5	H830 W2400 D510 SH450	£718

Product Name	Product Code	Fabric Groups						
		1	2	3	4	5	6	7
Seat pad – individual	MATAUPHPAD	£58	£63	£76	£90	£111	£141	£180
Seat pad – batch of 2	MATAUPHPAD/2	£46	£48	£55	£62	£72	£87	£107
Seat pad – batch of 5	MATAUPHPAD/5	£41	£42	£46	£51	£57	£66	£78
Seat pad – batch of 100+	MATAUPHPAD/100	£34	£35	£38	£41	£46	£53	£62

If fabrics in two or more different groups are used on one product it will be priced in the highest group. For any patterned or velvet fabrics a 10% surcharge is applied.

Optional Features and Prices ● Standard ○ Option x Not applicable

Option	Code	Price	MATABEAM2/3/4/5
Drilled for floor fixing	MATABEAM/FF	£28	○

Prima Beam















Each seat is certified to 32 stone, ideal for A&E or other areas with extreme use.

Product information

- Black beam
- Polypropylene or upholstered seat and back available
- Upholstered seat and back rests can be covered in fabric, leather or vinyl
- Round cornered square table option available in place of one or more beam seats. Price on application
- Feet can be drilled for floor fixing if required – free of charge – required on tip-up frames



▲ Round Cornered Table

Product Name	Product Code	Dimensions	Price	Fabric Groups						
				1	2	3	4	5	6	7
 Fixed Upholstered Seat Beam - 2 Seat	PF332	H835 W1200 D560 SH480	–	£639	£644	£660	£676	£701	£738	£785
 Fixed Polypropylene Seat Beam - 2 Seat	PF332/PP	H835 W1200 D560 SH480	£490	–	–	–	–	–	–	–
 Fixed Upholstered Seat Beam with Polypropylene Back - 2 Seat	PF332/UPH/PP	H835 W1200 D560 SH480	–	£657	£661	£674	£688	£709	£739	£779
 Fixed Upholstered Seat Beam - 3 Seat	PF333	H835 W1800 D560 SH480	–	£887	£894	£915	£937	£971	£1,019	£1,082
 Fixed Polypropylene Seat Beam - 3 Seat	PF333/PP	H835 W1800 D560 SH480	£669	–	–	–	–	–	–	–
 Fixed Upholstered Seat Beam with Polypropylene Back - 3 Seat	PF333/UPH/PP	H835 W1800 D560 SH480	–	£907	£912	£928	£945	£970	£1,006	£1,053
 rhubarb seating Fixed Upholstered Seat Beam - 4 Seat	PF334	H835 W2400 D560 SH480	–	£1,105	£1,114	£1,142	£1,171	£1,215	£1,279	£1,362
 Fixed Polypropylene Seat Beam - 4 Seat	PF334/PP	H835 W2400 D560 SH480	£815	–	–	–	–	–	–	–
 rhubarb seating Fixed Upholstered Seat Beam with Polypropylene Back - 4 Seat	PF334/UPH/PP	H835 W2400 D560 SH480	–	£1,118	£1,123	£1,140	£1,156	£1,181	£1,218	£1,265
 rhubarb seating Fixed Upholstered Seat Beam - 5 Seat	PF335	H835 W3000 D560 SH480	–	£1,331	£1,342	£1,377	£1,413	£1,467	£1,546	£1,648
 rhubarb seating Fixed Polypropylene Seat Beam - 5 Seat	PF335/PP	H835 W3000 D560 SH480	£969	–	–	–	–	–	–	–
 rhubarb seating Fixed Upholstered Seat Beam with Polypropylene Back - 5 Seat	PF335/UPH/PP	H835 W3000 D560 SH480	–	£1,358	£1,366	£1,390	£1,415	£1,452	£1,507	£1,578

If fabrics in two or more different groups are used on one product it will be priced in the highest group. For any patterned or velvet fabrics a 10% surcharge is applied.

Optional Features and Prices ● Standard ○ Option x Not applicable

Option	Code	Price	PF332	PF333	PF334	PF335
Soft feel polyurethane arms (each)	10065	£63	○	○	○	○

Prima Beam – Tip-Up Seat















Product information

- Black beam
- Polypropylene or upholstered seat and back available
- Upholstered seat and back rests can be covered in fabric, leather or vinyl
- Round cornered square table option available in place of one or more beam seats. Price on application
- Feet can be drilled for floor fixing if required – free of charge – required on tip-up frames



▲ Round Cornered Table

Product Name	Product Code	Dimensions	Price	Fabric Groups						
				1	2	3	4	5	6	7
 Tip-Up Upholstered Seat Beam - 2 Seat	PT336	H790 W1200 D490 SH490	–	£745	£750	£766	£783	£807	£844	£891
 Tip-Up Polypropylene Seat Beam - 2 Seat	PT336/PP	H790 W1200 D490 SH490	£588	–	–	–	–	–	–	–
 Tip-Up Upholstered Seat Beam with Polypropylene Back - 2 Seat	PT336/UPH/PP	H790 W1200 D490 SH490	–	£763	£767	£781	£794	£815	£846	£885
 Tip-Up Upholstered Seat Beam - 3 Seat	PT337	H790 W1800 D490 SH490	–	£1,040	£1,047	£1,069	£1,091	£1,124	£1,173	£1,236
 Tip-Up Polypropylene Seat Beam - 3 Seat	PT337/PP	H790 W1800 D490 SH490	£826	–	–	–	–	–	–	–
 Tip-Up Upholstered Seat Beam with Polypropylene Back - 3 Seat	PT337/UPH/PP	H790 W1800 D490 SH490	–	£1,065	£1,070	£1,087	£1,103	£1,128	£1,165	£1,212
 Tip-Up Upholstered Seat Beam - 4 Seat	PT338	H790 W2400 D490 SH490	–	£1,307	£1,316	£1,345	£1,373	£1,417	£1,481	£1,564
 Tip-Up Polypropylene Seat Beam - 4 Seat	PT338/PP	H790 W2400 D490 SH490	£1,024	–	–	–	–	–	–	–
 Tip-Up Upholstered Seat Beam with Polypropylene Back - 4 Seat	PT338/UPH/PP	H790 W2400 D490 SH490	–	£1,329	£1,334	£1,350	£1,367	£1,392	£1,428	£1,475
 Tip-Up Upholstered Seat Beam - 5 Seat	PT339	H790 W3000 D490 SH490	–	£1,582	£1,593	£1,628	£1,664	£1,718	£1,797	£1,899
 Tip-Up Polypropylene Seat Beam - 5 Seat	PT339/PP	H790 W3000 D490 SH490	£1,231	–	–	–	–	–	–	–
 Tip-Up Upholstered Seat Beam with Polypropylene Back - 5 Seat	PT339/UPH/PP	H790 W3000 D490 SH490	–	£1,621	£1,629	£1,653	£1,678	£1,715	£1,770	£1,841

If fabrics in two or more different groups are used on one product it will be priced in the highest group. For any patterned or velvet fabrics a 10% surcharge is applied.

Optional Features and Prices ● Standard ○ Option x Not applicable

Option	Code	Price	PF336	PF337	PF338	PF339
Soft feel polyurethane arms (each)	10065	£63	○	○	○	○

















Tala



Product information

- Metal powder-coated frame
- Metal seats
- Upholstered seat and back available
- Range of arm and leg options available
- Square tables available in place of one or more beam seats, price on application
- EN 16139:2013 (safety, strength and durability of all types of non-domestic seating)

Please note that there is an extended lead time on Tala beams of approximately 6 weeks

Product Name	Product Code	Dimensions	Price
 Tala 2 Seater with Floor Fixing Leg	TALA/2/FF	H800 W1160 D615 SH440	£730
 Tala 3 Seater with Floor Fixing Leg	TALA/3/FF	H800 W1710 D615 SH440	£815
 Tala 4 Seater with Floor Fixing Leg	TALA/4/FF	H800 W2260 D615 SH440	£1,010
 Tala 5 Seater with Floor Fixing Leg	TALA/5/FF	H800 W2800 D615 SH440	£1,094
 Tala 2 Seater with Floor Fixing Leg & Arms	TALA/2/A/FF	H800 W1260 D615 SH440	£1,298
 Tala 3 Seater with Floor Fixing Leg & Arms	TALA/3/A/FF	H800 W1810 D615 SH440	£1,384
 Tala 4 Seater with Floor Fixing Leg & Arms	TALA/4/A/FF	H800 W2360 D615 SH440	£1,644
 Tala 5 Seater with Floor Fixing Leg & Arms	TALA/5/A/FF	H800 W2900 D615 SH440	£1,732
 Tala 2 Seater with Slim Arm & Leg	TALA/2/SLIM	H800 W1160 D615 SH440	£906
 Tala 3 Seater with Slim Arm & Leg	TALA/3/SLIM	H800 W1710 D615 SH440	£1,135
 Tala 4 Seater with Slim Arm & Leg	TALA/4/SLIM	H800 W2260 D615 SH440	£1,469
 Tala 5 Seater with Slim Arm & Leg	TALA/5/SLIM	H800 W2800 D615 SH440	£1,836
 Tala 2 Seater with Cut Arm & Leg	TALA/2/CUT	H800 W1160 D615 SH440	£982
 Tala 3 Seater with Cut Arm & Leg	TALA/3/CUT	H800 W1710 D615 SH440	£1,261
 Tala 4 Seater with Cut Arm & Leg	TALA/4/CUT	H800 W2260 D615 SH440	£1,540
 Tala 5 Seater with Cut Arm & Leg	TALA/5/CUT	H800 W2800 D615 SH440	£1,936
Tala Slim Arm & Bracket (each)	TALA/SLIMARM		£112
Tala Cut Arm & Bracket (each)	TALA/CUTARM		£112

Product Name	Product Code	Fabric Groups						
		1	2	3	4	5	6	7
Upholstery Seat Pad	TALA/SP	£71	£73	£81	£89	£101	£119	£143
Upholstery Back Pad	TALA/BP	£57	£59	£65	£71	£81	£95	£113

Office, Task & Guest Chair Mechanisms

We offer a wide choice of chair mechanisms to provide a full range of adjustments to suit particular tasks and individual needs.

All mechanisms are of the finest quality and have only been selected after thousands of hours of continuous testing. All swivel chairs are fitted with top quality pneumatic gas height adjustments as standard.



Knee Tilt

Tilt mechanism can be locked in the upright position or free-floating. Seat and backrest are fixed. Adjustable tension control.



Easy Lift Back

Ratchet mechanism allows easy adjustment whilst seated.



Synchro Mechanism

Fully synchronised 2:1 ratio mechanism enables seat and backrest angle to be adjusted to required position.



Anti-Kick

This feature requires the user's to lean back into the chair before the backrest rake can be adjusted. This eliminates the risk of the backrest springing into the user's back.



Seat Slider

Sliding seat mechanism increases seat depth and enhances leg support.



Independent Seat and Back Mechanism

Seat and back can be independently adjusted to suit individual requirements using side adjustable tension control. Can be locked into position or remain free floating.



Inflatable Lumbar

Inflatable air bag built into seat backrest to adjust support for the lumbar region.



Special Order Castors

Soft wheeled castors for hard floor environments. Suitable for all Rhubarb chairs.



Height Adjustable Back with Wheel Locking Screw

Backrest fully adjustable for height.

Brake Unloaded Castors

Castors brake when user gets off seat.

Brake Loaded Castors

Castors brake when user sits on seat.

Chair Sizing Guide

This sizing guide shows the approximate points we have taken for the indicative measurements of products throughout this brochure.

Every care has been taken to ensure the accuracy of these measurements, but we recommend to customers that product samples are requested in advance of any orders where absolute precision of dimensions will be critical.

Please note that different makes of castors, gas struts and foam do make a difference to height measurements.

For Soft Seating "D" dimension represents the overall depth of the unit. "SD" is also provided as the seat depth.

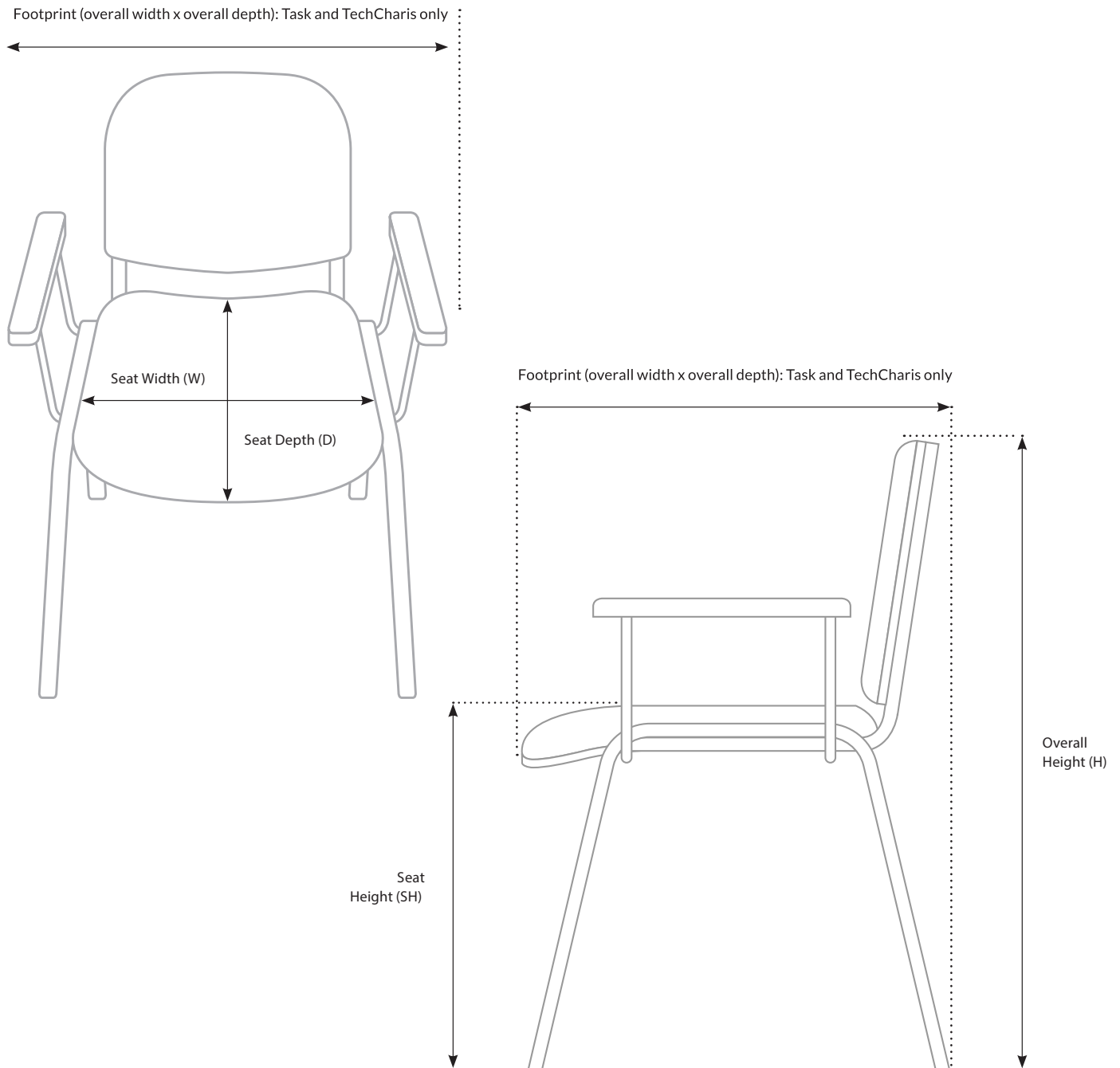

Professional Memberships & Accreditations

- ISO 90001 Quality Assurance
- ISO 14001 Environmental Management
- PAS 2060 Carbon Neutrality
- FISP Furniture Sustainability Programme
- FSC® Certified Chain-of-custody certificate holders
- FIRA Quality & Production efficiency
- Constructionline Currently Bronze, working towards Gold + holders of Constructionline Social Value certificate
- Interface Registered with a Carbon Reduction Pilot to start our journey to net zero*
- Commercial Interiors UK UK's largest trade association representing the commercial interiors sector

*The programme is part of the accreditation process for ISO 14064 and PAS 2060 accreditation



We design for green, not for the bin

The climate agenda has rapidly become a mainstream priority rather than a side-line and it is changing our attitudes and behaviours.

In our industry, that means people are increasingly looking for ways to reuse the furniture they have rather than throw it away and replace it with something new.

We are constantly amazed by the number of pieces we are asked to re-upholster that have been designed in a way that makes them incredibly difficult to refurbish because they can't easily be disassembled.

Here at Rhubarb, we design all our seating with sustainability in mind. Everything is made for the long term. Our cores and frames are robust with no compromises on the quality of the build, so when the fabric and the foams get tired or wear out, we can easily strip them back and refresh the whole look, just like new!

Our entire seating range is made to minimise component damage when stripped for refurbishment and therefore maximise reuse. We even consider how our products can be refurbished on-site to remove the need for costly and polluting transport to and from our factory.

Environmental Policy

We recognise that, as a manufacturer and supplier of office and contract chairs and tables, we have a responsibility to do what we can to make sure we do not contribute to further destruction of our environment. We want to lead by example and make Rhubarb a model company renowned for environmental best practice; so we are continually working towards minimising our environmental impact and doing our utmost to reduce our environmental footprint to a tip toe!

To achieve our aims we will establish sound environmental management by:

- Ensuring that, as a minimum requirement, we conduct our operations in full compliance with all relevant legislation, regulations and environmental codes of practice applicable to our operations, so as to minimise any pollution of the environment.
- Protecting the environment from our activities, including prevention of pollution
- Seeking to continually improve our environmental performance and our environmental management system by setting and reviewing environmental aspects, objectives and targets, making environmental improvements and monitoring performance by regular review
- Considering any environmental issues as part of our normal decision making process
- Developing a relationship with suppliers and contractors and encourage them to manage their environmental impacts more effectively
- Reviewing this Environmental Policy at least annually, or when there are any significant changes either to our operations or to environmental legislation.
- Our immediate environmental objectives are:
 - Waste reduction and recycling
 - Sustainable sourcing and product
 - Maximising energy efficiency
- This policy will be made available to all interested parties on request.

Rhubarb Seating Limited

Terms of Business at 1st March 2024.

The following are the terms ("Terms") on which Rhubarb Seating Limited ("we" "our" or "us") have agreed to supply goods ("Goods") to you ("you" or "your").

1. Orders

- 1.1 You may place an order for Goods from us only by written form of communication and no orders for Goods submitted by you shall be deemed to be accepted by us unless and until confirmed in writing by us ("Confirmation").
- 1.2 You shall be responsible for ensuring the accuracy of all the terms of any order and for checking that the Confirmation is correct and no order which we have accepted may be cancelled by you.
- 1.3 These Terms apply to the exclusion of any other terms that you seek to impose.
- 1.4 We reserve the right to discontinue products and change product specifications at any time

2. Delivery

- 2.1 Delivery of the Goods shall be made by us delivering the Goods to your premises in the UK as notified to us at the time of your order or directly, on request, to an end-user in the UK. Unless quoted otherwise, delivery for a single drop over £750 within the post codes scheduled in Appendix A is free of charge except for below in respect of fines. Additional charges equivalent to the cost to us for delivery will be payable by you should you specify delivery of the Goods anywhere outside of those post codes or where the delivery incurs tolls, congestion, or other such charges. Delivery charges for drops outside of the post codes scheduled in Appendix A are set out in Appendix B. "Delivery" is defined as 1 man tail gate delivery between the hours of 8.30am and 5.00pm Monday to Friday. Out of hours delivery may be subject to additional charges and must be agreed in writing prior to delivery. The customer must ensure that suitable parking together with an appropriate number of their own staff are able to receive the goods without delaying the vehicle beyond 15 minutes. 15 minutes after arrival at the closest legal parking point, the driver will be entitled to leave and Section 2.5 will apply. Should our drivers incur any traffic penalty fines due to access restrictions we have not been made aware of in writing prior to delivery, the cost of any such penalty will be added to the Goods invoice and will be payable by the Customer within 30 days of invoice.
- 2.2 All goods must be checked for any damage and details of the damage noted in writing before the vehicle leaves.
- 2.3 Any dates quoted for delivery of the Goods are approximate only; we shall not be liable for any customer costs incurred as a result in the delay in delivery of the Goods.
- 2.4 We will use reasonable endeavors to ensure that the quantity, size and description of the Goods delivered conform to those ordered by you, as set out in the Confirmation, although minor variations may occur.
- 2.5 If you fail to take delivery of the Goods then, without prejudice to any other right or remedy available to us delivery of the Goods shall be deemed to have been completed at the time you failed to take delivery; and, (i) we may store the Goods until actual delivery and charge you for the reasonable costs, including insurance and storage; or (ii) we may sell the Goods at the best price readily obtainable and (after deducting all reasonable storage and selling expenses) account to you for any excess over the price payable or charge you for any shortfall below that price.
- 2.6 We may deliver the Goods by instalments, which shall be invoiced and paid for separately. Each instalment shall constitute a separate supply of Goods. Any delay in delivery or defect in an instalment shall not entitle you to cancel any other instalment.

3. Price

- 3.1 The price of the Goods shall be the price agreed when the Goods are ordered from us as set out in the last Confirmation and we will not be responsible for any losses caused to you by reason of fluctuation in currency exchange rates between the date when the Goods were ordered and when they are delivered. All prices quoted are valid only for the particular order which you make.
- 3.2 Subject to clauses 2.1 and 2.2 above, all prices are given by us inclusive of costs of carriage unless otherwise agreed in writing.
- 3.3 All prices are exclusive of value added tax, which you shall be additionally liable to pay to us.

4. Terms of Payment

- 4.1 We shall be entitled to invoice you at any time after delivery or deemed delivery of the Goods and you shall pay the price of the Goods within 30 days of the date of our invoice or on such other terms as are agreed in writing by us or, stated in the Confirmation. For the avoidance of doubt, delivery will be deemed to take place on the date agreed with you, as confirmed in our order acknowledgement.
- 4.2 If you fail to make any payment on the due date then, without prejudice to any other right or remedy available to us, we shall be entitled to (i) cancel the order for Goods and suspend any further deliveries to you; and (ii) charge you interest (both before and after any judgment) on any sum until payment in full is made unpaid at the rate of 4% per annum above Barclays Bank Plc base rate from time to time.

5. Risk and Property

- 5.1 The Goods shall be at your risk as from delivery.
- 5.2 The Goods shall not pass from us until (i) we have received payment in full in cleared funds for the Goods plus VAT; and, no other sums whatever shall be due from you to us.
- 5.3 Until title to the Goods passes you shall hold the Goods on our behalf. You shall store the Goods (at no cost to us) separately from all other goods in your possession and marked in such a way that they are clearly identified as our property and shall maintain the Goods in satisfactory condition.
- 5.4 We shall be entitled to recover the full price for any Goods sold under these Terms including VAT, notwithstanding that the title in such Goods has not passed from us.
- 5.5 If (before title to the Goods passes to you) you become subject to any of the events listed in clause 7.1.(ii) – 7.1.(v) or we reasonably believe that any such event is about to happen and notify you accordingly, then, provided the Goods have not been sold, or irrevocably incorporated into another product, and without limiting any other right or remedy we may have, we may at any time require you to deliver up the Goods and, if you fail to do so promptly we may enter any vehicle or premises where the Goods are stored in order to recover them.
- 5.6 You shall not pledge or in any way charge by way of security for any indebtedness any of the Goods which are our property.
- 5.7 You shall insure and keep insured the Goods to their full price against "all risks" to our reasonable satisfaction until the title in the Goods passes from us.
- 5.8 Without prejudice to our other rights, if you fail to comply with your obligations under this clause 5, all sums whatsoever owing by you to us shall immediately become due and payable.

6. Warranties and Liability

- 6.1 Subject to the remainder of this clause 6 and excluding upholstery fabrics not specifically recommended by the manufacturer for severe wear, we warrant that the Goods will be of satisfactory quality at the time of delivery for a period of 6 years after delivery, with the additional exception of those Goods which are specified to be used for continuous and consecutive periods of 24 hours in respect of which we warrant they will be of satisfactory quality for a period of 2 years after delivery.
- 6.2 We shall be under no liability under the above warranty in respect of the following matters:-
- 6.2.1 if you make any use of Goods after giving a notice in accordance with clause 6.4, or the defect arises because you failed to follow our verbal or written instructions as to the storage, installation, commissioning, use or maintenance of the Goods or (if there are none) good trade practice, or you alter or repair such Goods without our written consent, or the defect arises as a result of fair wear and tear, willful damage, negligence, or abnormal working conditions;
- 6.2.2 if the production identification label detailing the model, order number and date of production has been removed from the goods
- 6.2.3 if the total price for the Goods has not been paid by the due date for payment;
- 6.2.4 for the condition of Goods which are modified after delivery or for any expenses incurred in connection with such modification
- 6.2.5 If stated in writing prior to delivery.
- 6.3 Subject as expressly provided in these conditions all warranties conditions or other terms implied by statute or common law are excluded to the fullest extent permitted by law.
- 6.4 Any claim by you which is based on any defect in the quality or condition of the Goods must be made in writing to us within 48 hours of receipt of the same otherwise you shall not be entitled to reject the Goods. In the case of a quality dispute the Goods should be retained by you for inspection by us.
- 6.5 Where any valid claim in respect of any of the Goods which is based on any defect in the quality or condition of the Goods is notified to us in accordance with these Terms, we shall be entitled to replace such Goods free of charge or, at our sole discretion, refund to you the price of the Goods, but shall have no further liability to you.
- 6.6 Where a warranty claim is proved to be invalid we shall be entitled to charge an administration fee of £75 plus reasonable costs of collection and delivery of the Goods.
- 6.7 Except in respect of death or personal injury caused by our negligence, our entire liability under or in connection with these Terms shall not exceed the price of the Goods.
- 6.8 Notwithstanding anything else contained in these Terms we shall not be liable to you for loss of profits or contracts, indirect or consequential losses whether arising from negligence, breach of contract or otherwise.

7. Termination

- 7.1 We shall be entitled to terminate the supply of Goods hereunder immediately by written notice to you if (i) you commit any continuing or material breach of any of the provisions of these Terms and, in the case of a breach which is capable of remedy, you fail to remedy the same within 30 days after receipt of a written notice giving full particulars of the breach and requiring it to be remedied;(ii) an encumbrancer takes possession or a receiver (or similar office holder) is appointed over any of your property or assets; (iii) you make any voluntary (or similar) arrangement with your creditors or an administrator is appointed or you are subject to insolvency proceedings in any jurisdiction; (iv) you go into liquidation (except for the purposes of an amalgamation, reconstruction or other reorganisation and in such manner that the company resulting from the reorganisation effectively agrees to be bound by or to assume the obligations imposed on that other party under these Terms); or (v) you cease, or threaten to cease, to carry on business.

- 7.2 If any of the events set out in clause 7.1 occurs we shall be entitled to cancel the supply of Goods hereunder or suspend any further deliveries without liability to you, and if the Goods have been delivered but not paid for the price shall become immediately due.

8. General

- 8.1 We shall not be responsible for any delays in performing, or for any failure to perform, any of our obligations hereunder if the delay or failure was due to any cause beyond our reasonable control.
- 8.2 If any provision of these Terms is declared by any judicial or any other competent authority to be void, voidable, illegal or otherwise unenforceable or indications to that effect are received by us from any competent authority then that provision shall be limited or eliminated to the minimum extent necessary so these Terms shall otherwise remain in full force and effect and enforceable.
- 8.3 Each party acknowledges that these Terms contain the entire agreement between you and us and that you have not relied on any verbal or written representations made by us or our employees or agents.
- 8.4 These Terms supersede any prior agreement whether written or oral.
- 8.5 Any notice or other information required or permitted to be given under these Terms shall be deemed to have been validly given if served personally on that party or if sent by first class pre-paid post to the last known address of that party. If sent by first class pre-paid post the notice shall be deemed to have been received 2 days after the date of posting. If any such notice or other information is given by means of facsimile then notice shall be deemed to have been received on the same day if sent during normal working hours or on the next working day where sent outside such hours.
- 8.6 No variation of these Terms shall be binding unless made in writing and signed by you and us.
- 8.7 These Terms shall be governed by English law and the English Courts shall have exclusive jurisdiction to decide any dispute concerning these Terms.
- 8.8 No waiver by us of any breach of these Terms by you shall be considered as a waiver of any subsequent breach of the same or any other provisions.
- 8.9 These Terms shall not be enforceable by a person who is not a party to them under the Contracts (Rights of Third Parties) Act 1999 or otherwise.
- 8.10 Our policy is one of continual improvement. We therefore reserve the right to alter designs, dimensions, availability and price without prior notice.

Appendix A: Free delivery

See map for free delivery for single drops of value greater or equal to £750 (excluding VAT)

Appendix B: Delivery charges

Unless specifically agreed in writing delivery charges for all deliveries outside the map area in Appendix A above will be at the cost to us:

- Per van or boxed delivery within the UK mainland: £50.
- Per pallet within the UK mainland: on application. Sofas and beam seating sized 2 or more seats will be charged at 2 pallet rates per piece.
- Outside of the UK mainland – price on application

Fabric Advice

Fabric makes a huge difference both to the look of a product and to its durability so fabric selection is critically important. With so many different textures, colours and finishes being offered in today's marketplace we will work with you to make the best choices for each of our products and ensure that your selection is fit for the intended purpose.

This is an introduction to the key criteria to be considered when selecting the correct fabric.

Wool and Synthetic fabrics – Wool is used in many woven fabrics. Its softness and durability make it the obvious choice for soft seating or large seating units as it recovers well. Synthetic products, such as Polyester and Polypropylene, have a greater stretch and do not recover as well but are highly suitable for certain seating styles. Blends of natural and synthetic fibres often offer the best of both worlds, providing strength and durability as well as softness and ease of handling.

Vinyls or Faux leathers (synthetic leathers) – Vinyls (PVC – polyvinyl chloride) are commonly used for seating in high use environments such as education and healthcare. Specialist vinyls are available, resistant to blood and urine, antibacterial and antimicrobial treated, inherently FR to medium Hazard and importantly cleanable with diluted bleach-type solutions. The quality of faux leathers now is such that they look like the real thing but have the advantage of offering finishes that have the same characteristics as vinyls.

Fire Retardancy – All fabrics must confirm to either low hazard or medium hazard FR standards, according to the environment in which they are to be used:

Low Hazard

Offices
Schools
Colleges
Universities
Museums
Exhibition
Day Centres

Medium Hazard

Hotel Bedrooms
Hospitals
Public Buildings
Restaurants
Places of Public Entertainment
Public Houses and Bars
Bingo Halls

FR treatments are often applied to the fabric when the dying process takes place making the treatments integral to the fabric. Alternatively, the FR can be applied as an external coating.

Abrasion resistance – Abrasion is measured by the Martindale abrasion test, which is an industry British Standard and is measured in the forms of 'rubs'. British Standards conformance is for a fabric to achieve 40,000 rubs or more. Vinyls (or synthetic leathers) are also measured by this method or for 'flexing / cracking'.

Teflon (stain repellent) – Treatments such as Teflon, which are added to fabrics to make them more resistant to stains, liquids and general soiling, are often used on wool fabrics. There is less requirement on synthetics (polyesters / polypropylenes) as these yarn are derivatives of plastic and therefore more resistant to staining and soiling.

Anti-microbial qualities and treatments – this issue is more important than ever in all environments and we list below the website links for information from the fabric manufacturers with whom we work most closely:

Agua: <https://www.aguafabrics.com/aguaguard365/>
Camira: <https://www.camirafabrics.com/en/news-and-events/introducing-camira-staysafe>
Chieftan: <https://chieftainfabrics.com/technical-hub/coronavirus/>
Panaz: <http://www.panaz.com/en/shieldplus/>
Sunbury: <https://www.sunburydesign.com/everclean/>

If such properties are relevant to your decision making process you should research these websites and the technical teams at each manufacturer will be more than happy to provide further guidance if necessary

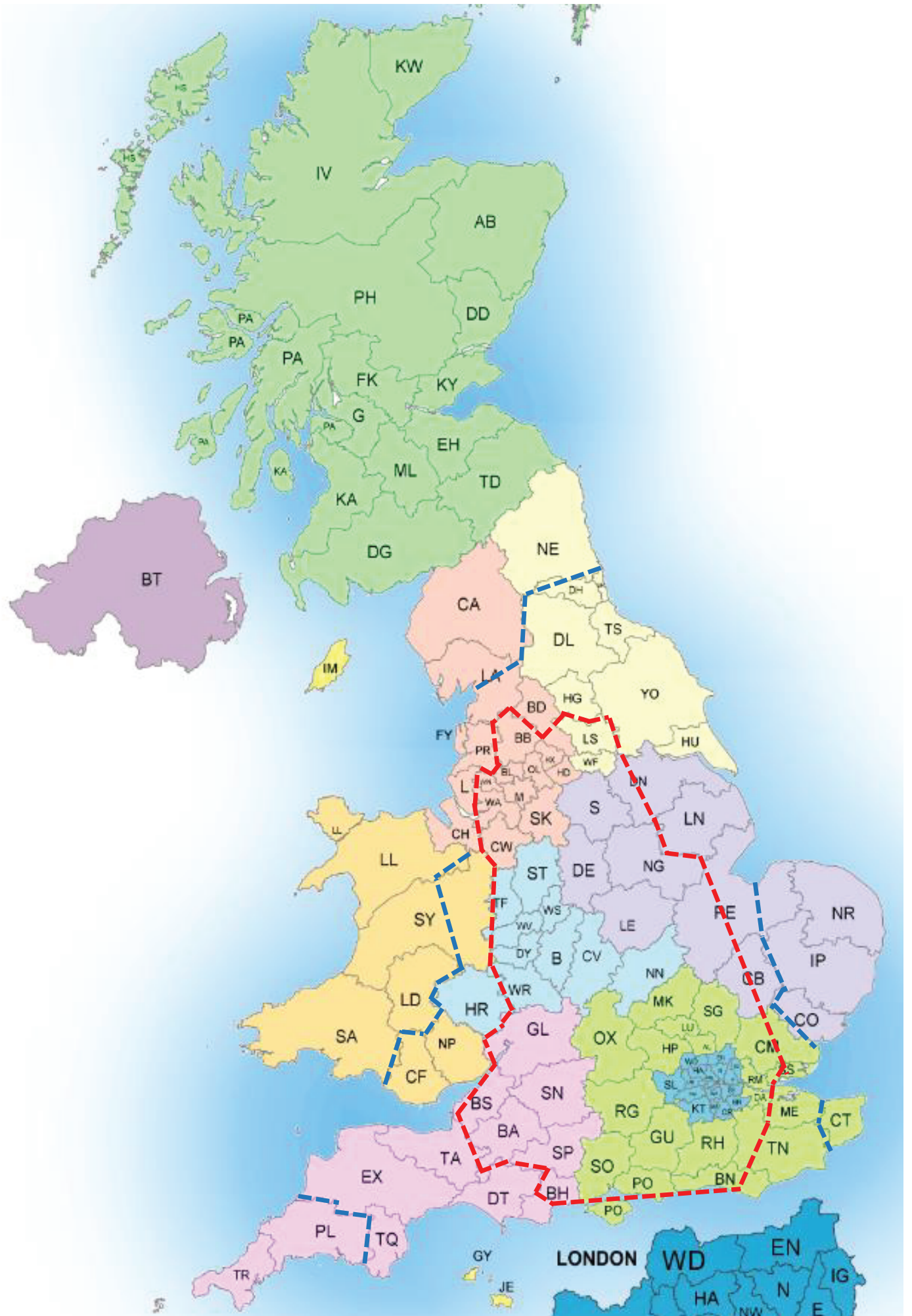

We put our customers at the heart of everything we do. Our aim is to exceed your expectations of product, service and quality.

We Design

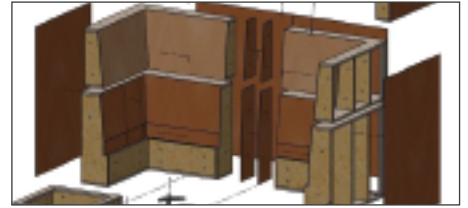

We Manufacture



We Cut

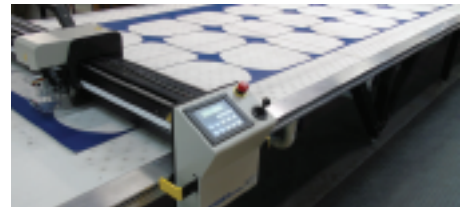

We Sew



We Upholster



We Deliver



You Enjoy



ISO
9001 : 2015
14001 : 2015
INTEGRATED
MANAGEMENT
SYSTEM
REGISTERED
Certificate
No.300872021